



TOP GUN MAVERICK

P-51D MUSTANG™



IN SERVICE - 1944 - 1957
 PLACE OF ORIGIN - UNITED STATES
 ROLE - FIGHTER
 CREW - 1
 WINGSPAN - 11.28_m (37')
 LENGTH - 9.83_m (32'3")
 HEIGHT - 4.08_m (13'4")
 WEIGHT - 3.465_{kg} (7.635_{lb})
 ENGINE - PACKARD MERLIN V-1650-7, 1490_{hp}
 RANGE - 2655_{km} (1650_{mi})
 RATE OF CLIMB - 16.3_{m/sec} (3,200_{ft/min})
 MAXIMUM FLIGHT LEVEL - 12,800_m (41,900_{ft})
 SPEED - 708_{km/h} (440_{mph})
 ARMAMENT - 6 × 12.7_{mm} (.50") BROWNING GUNS,
 453_{kg} (1,000_{lb}) BOMBS OR ROCKETS

scale
1:32

5846

Printed in EU



TM & © 2023 Paramount Pictures. All Rights Reserved



Produced under license from Boeing. Boeing, P-51 Mustang, the distinctive Boeing logos, product markings and trade dress are trademarks of The Boeing Company.

350 1



UK
CA

CE



WARNING: CHOKING HAZARD-
Toy contains small parts.
Not for children under 3 years.

1

BE CAREFUL: NOTICE THE DIFFERENCE

UWAGA: RÓŻNE KLOCKI

1:1

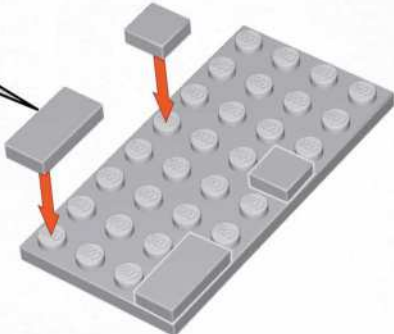

x1 x2 x2

2

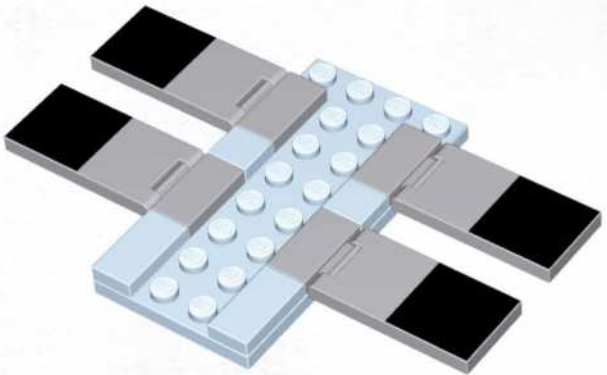

x4

x4 x4

3

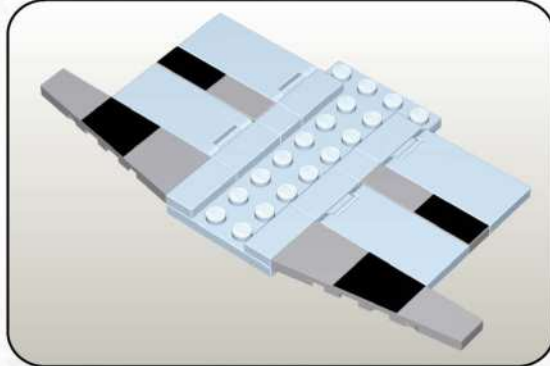
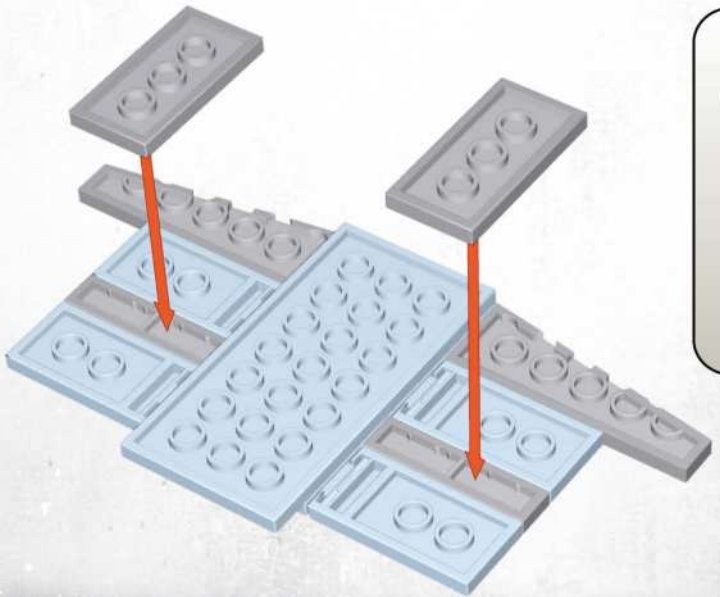

x2 x1 x1 x2

4

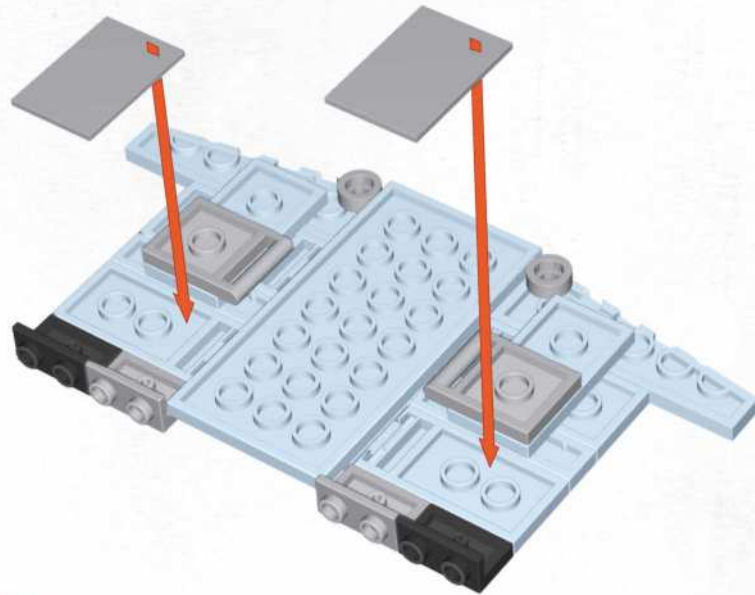

5

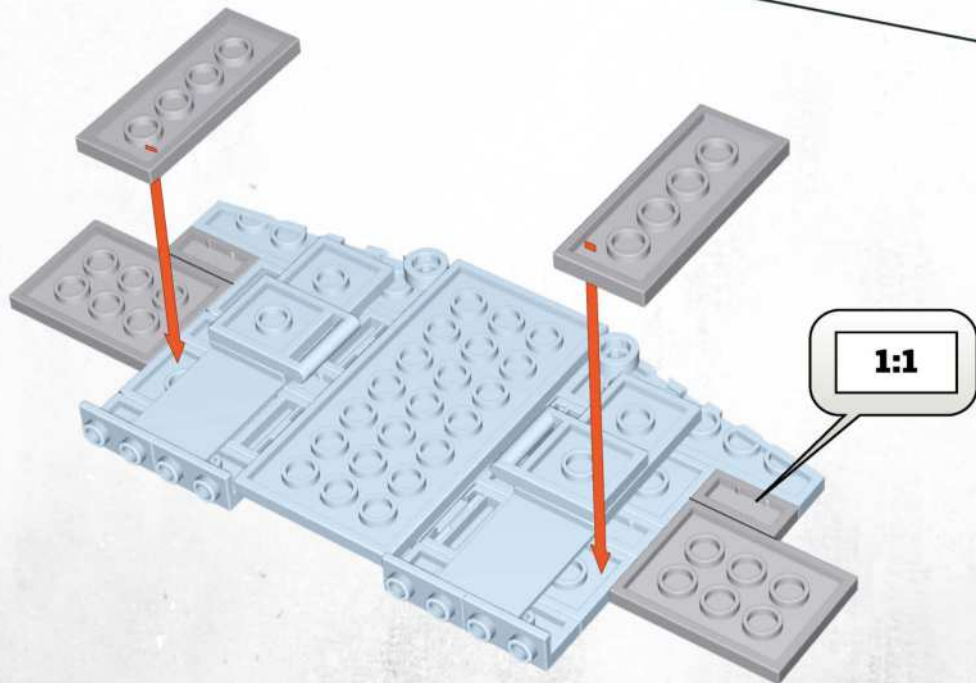



1:1

6

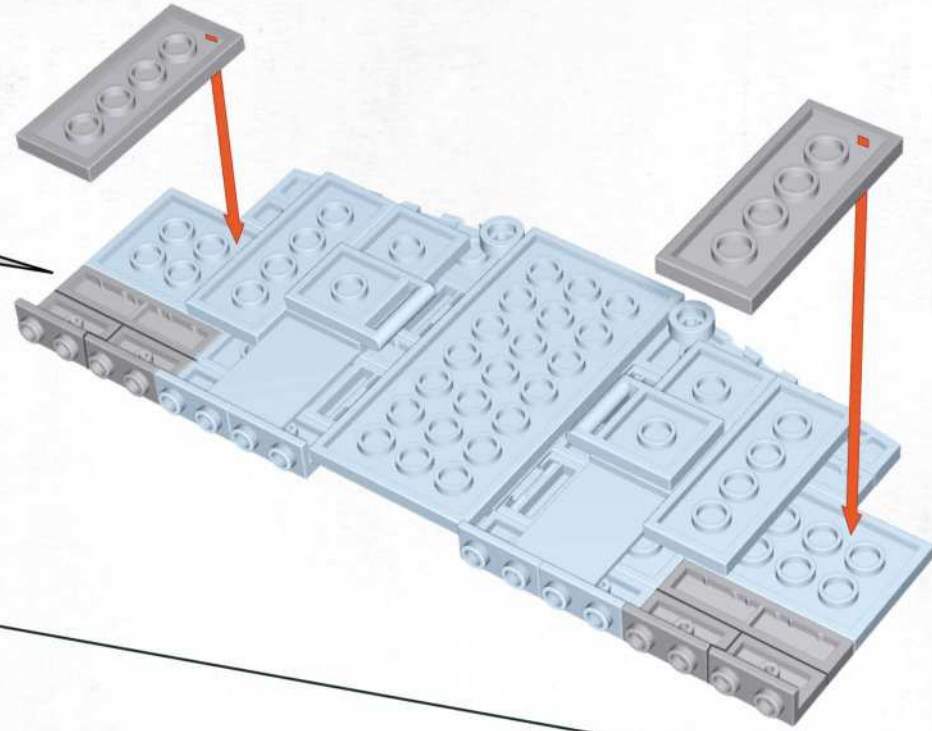
1:1



	
x4	x2
	
x2	

7

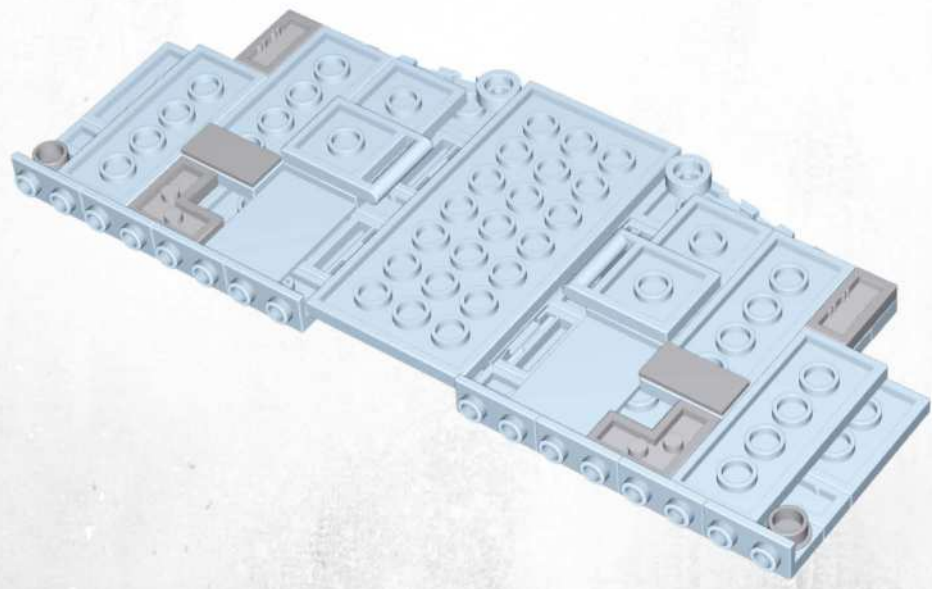

	
x2	x2
	
x2	x2

8

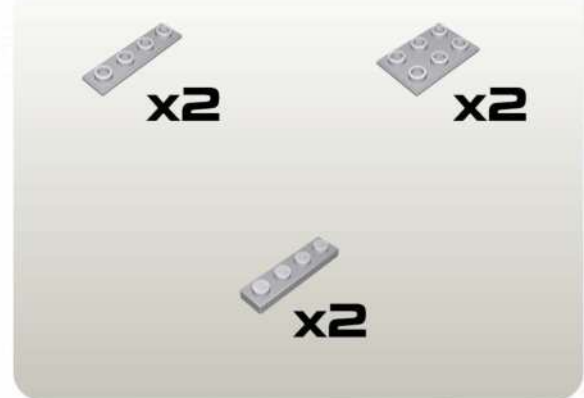
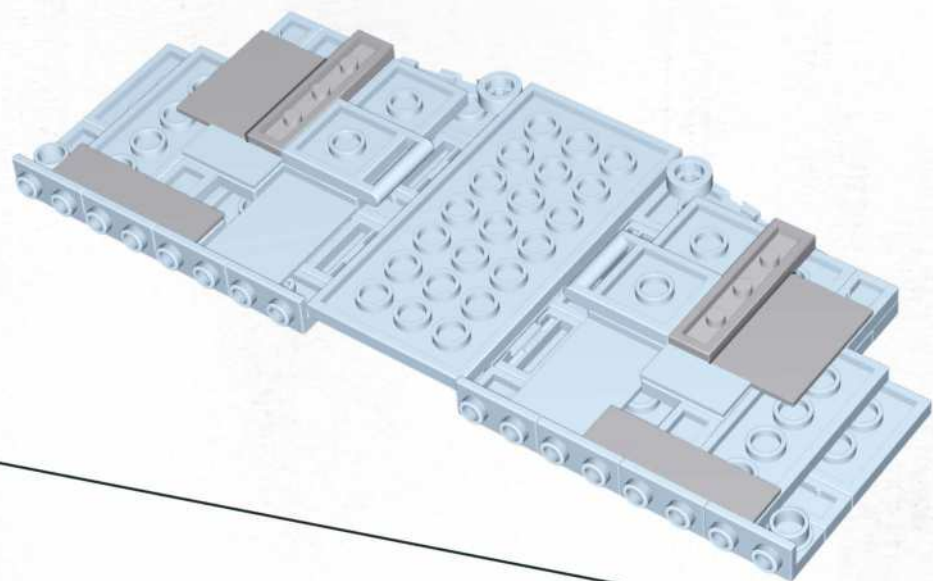

9

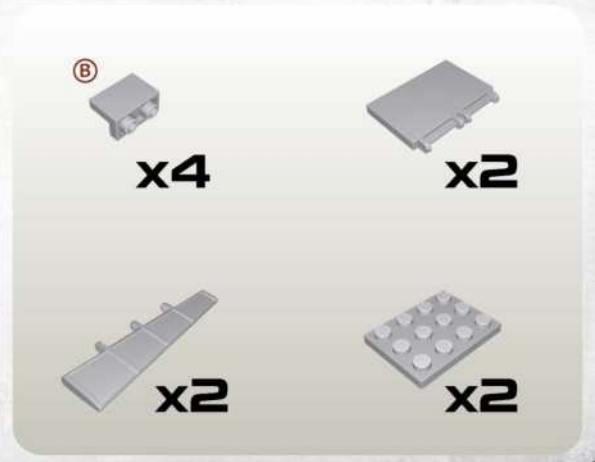
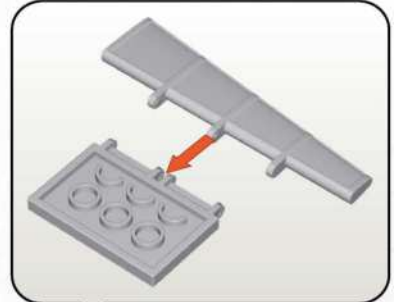
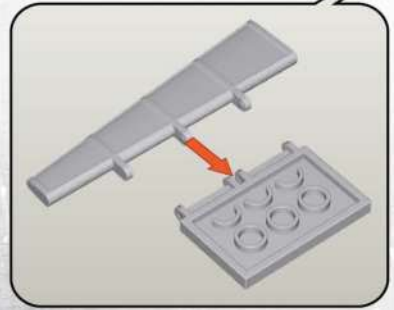
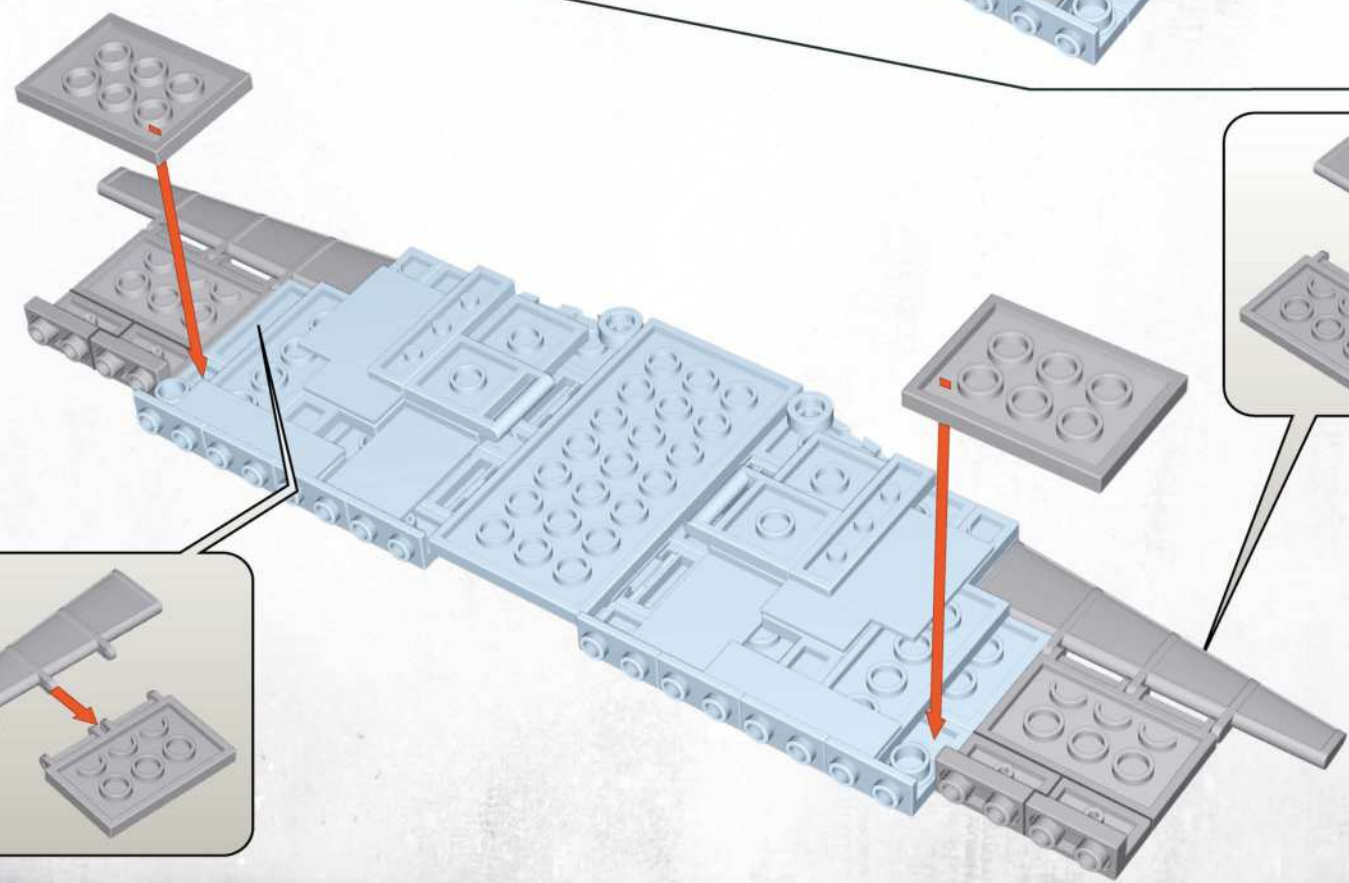

10

11

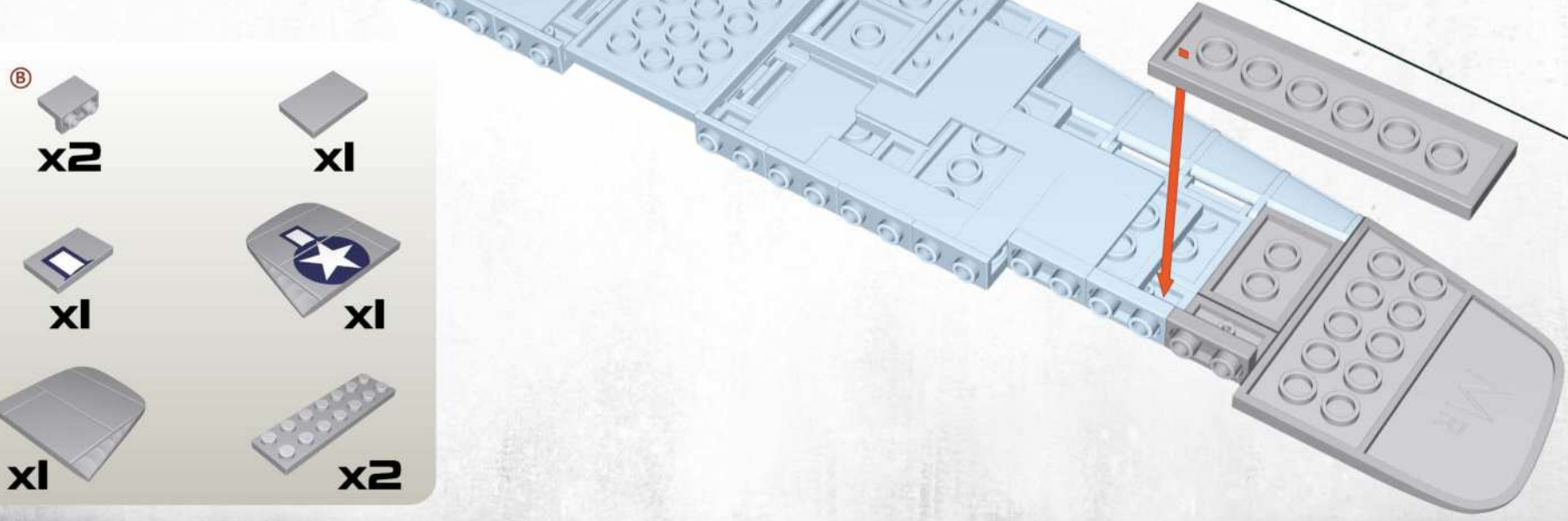
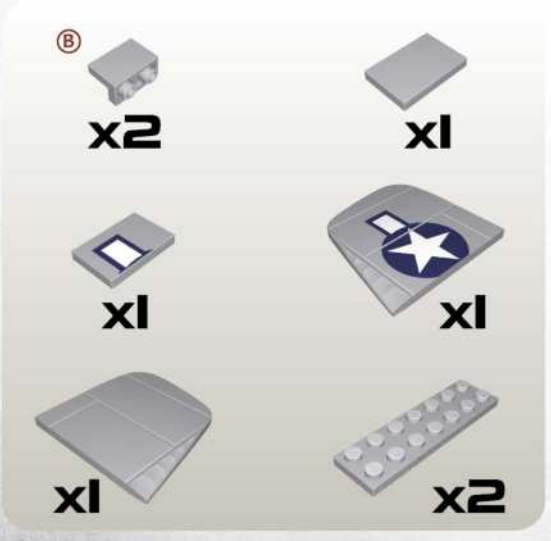
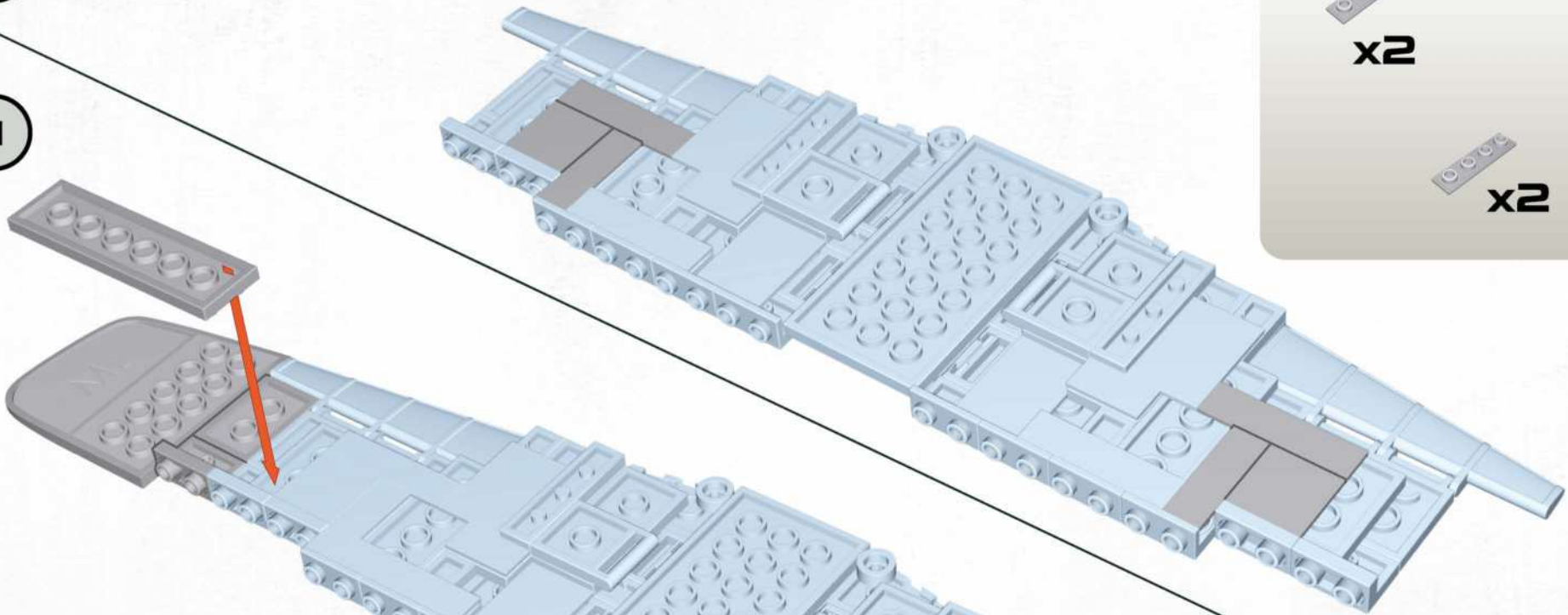
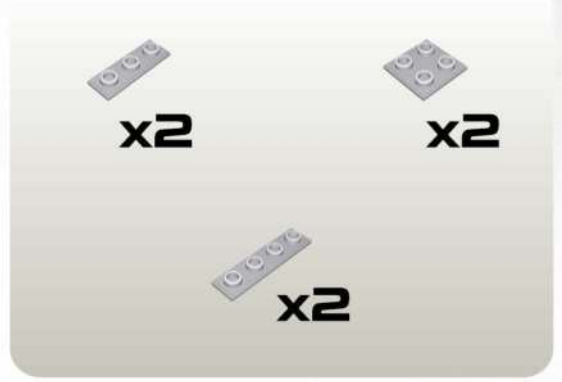

12

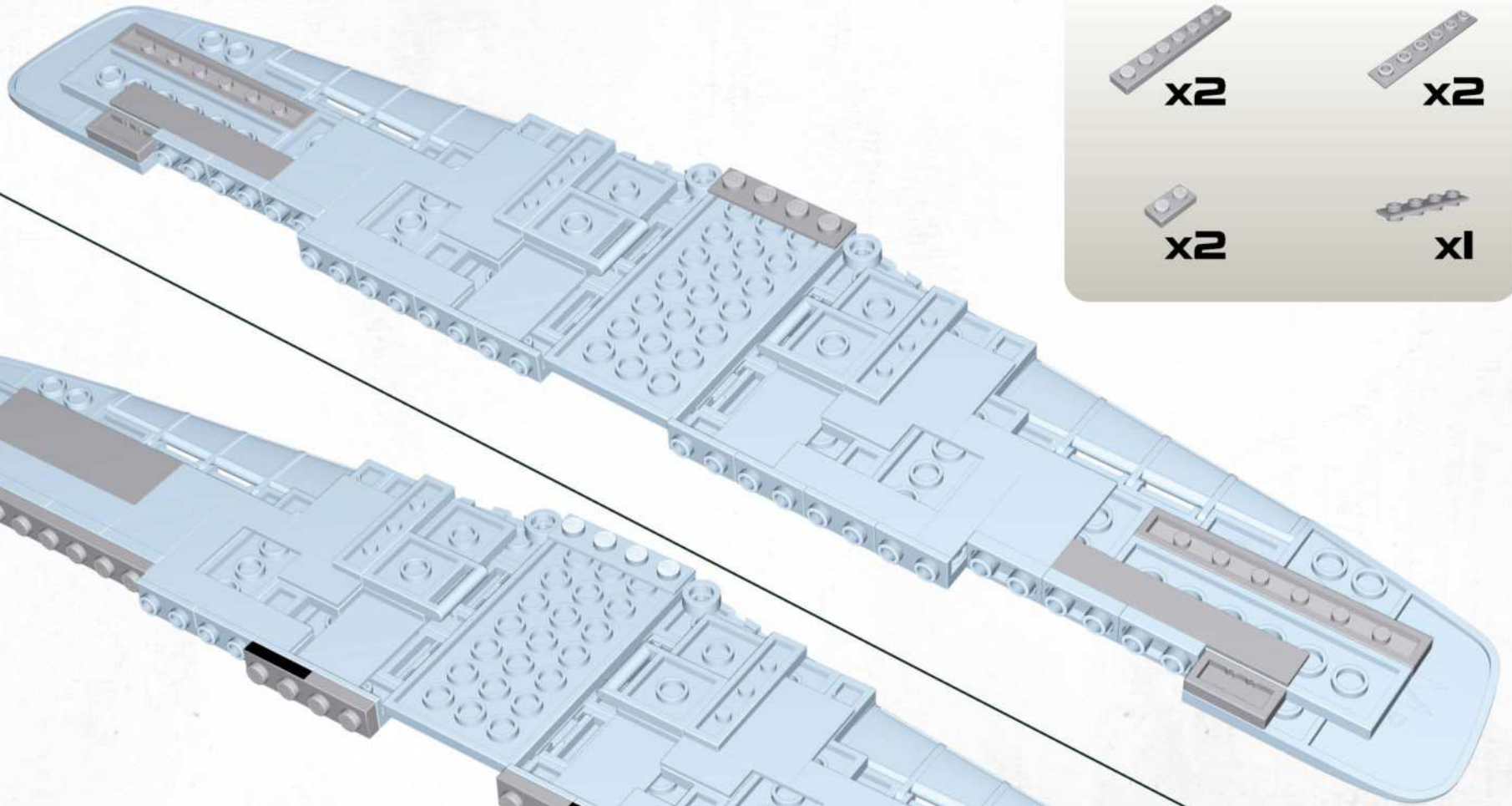

13

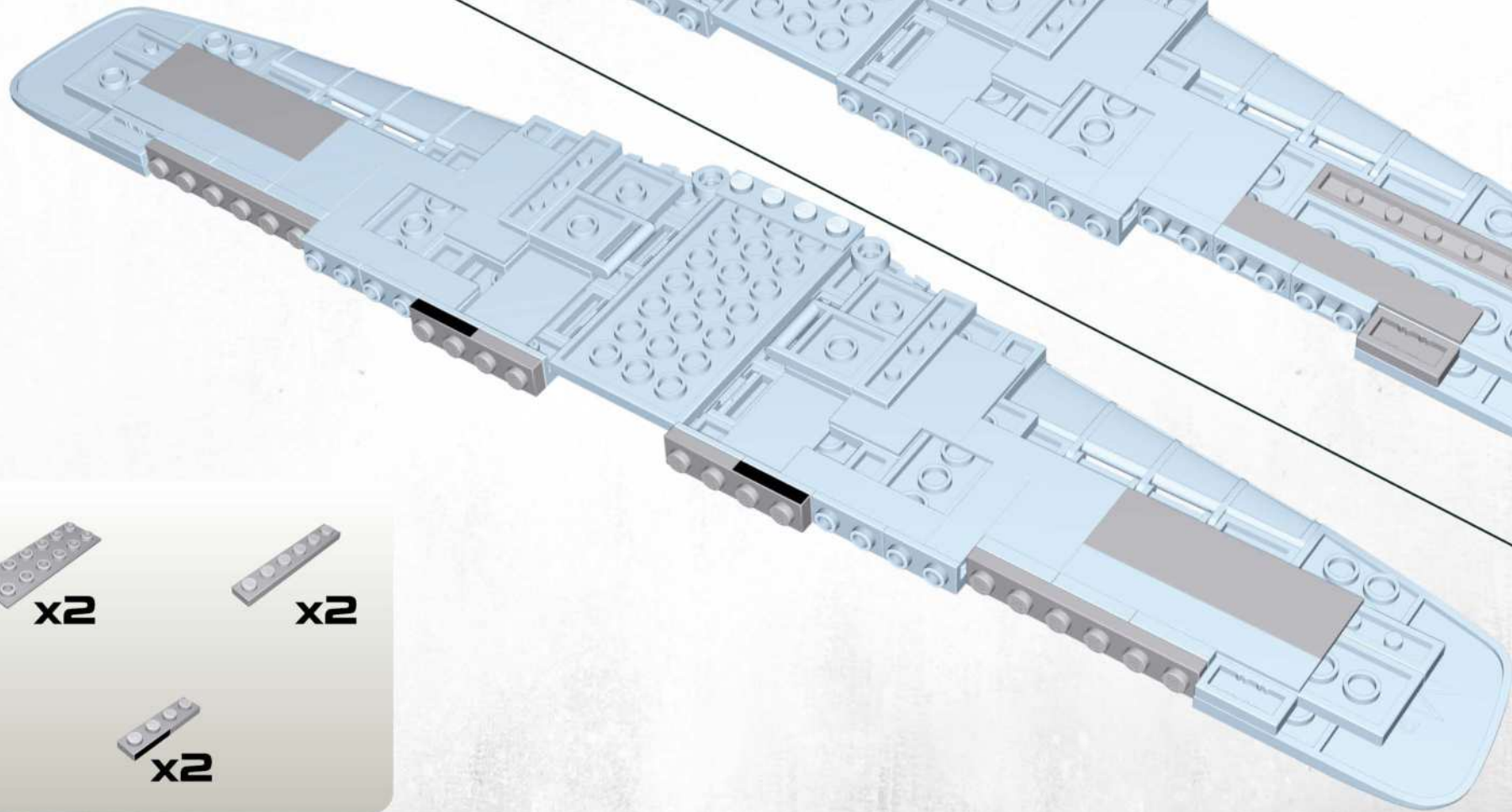

14

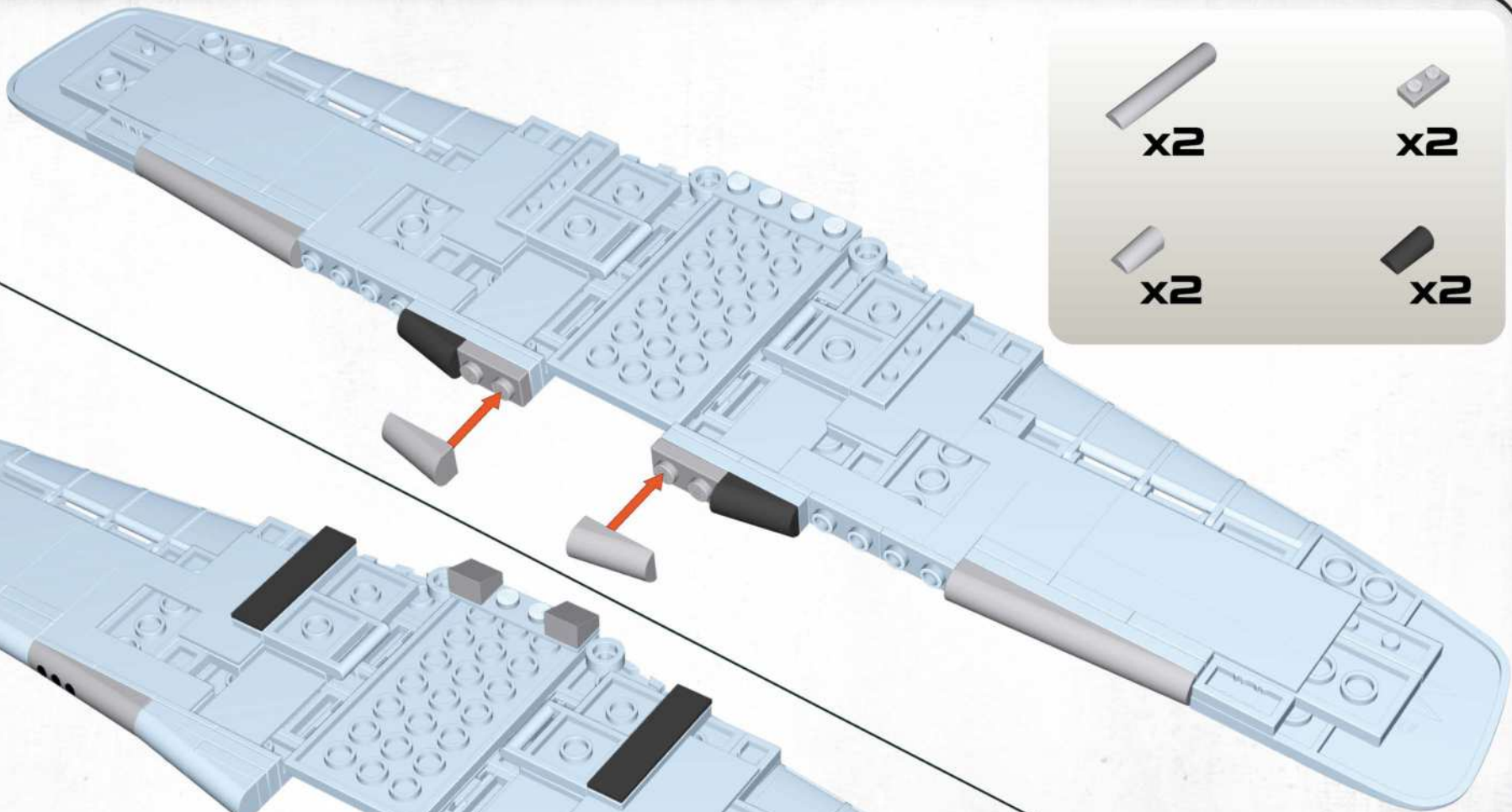

Grey Technic Pin x2 Grey 1x2 Technic Brick x2
Grey Technic Pin x2 Black Technic Pin x2

15

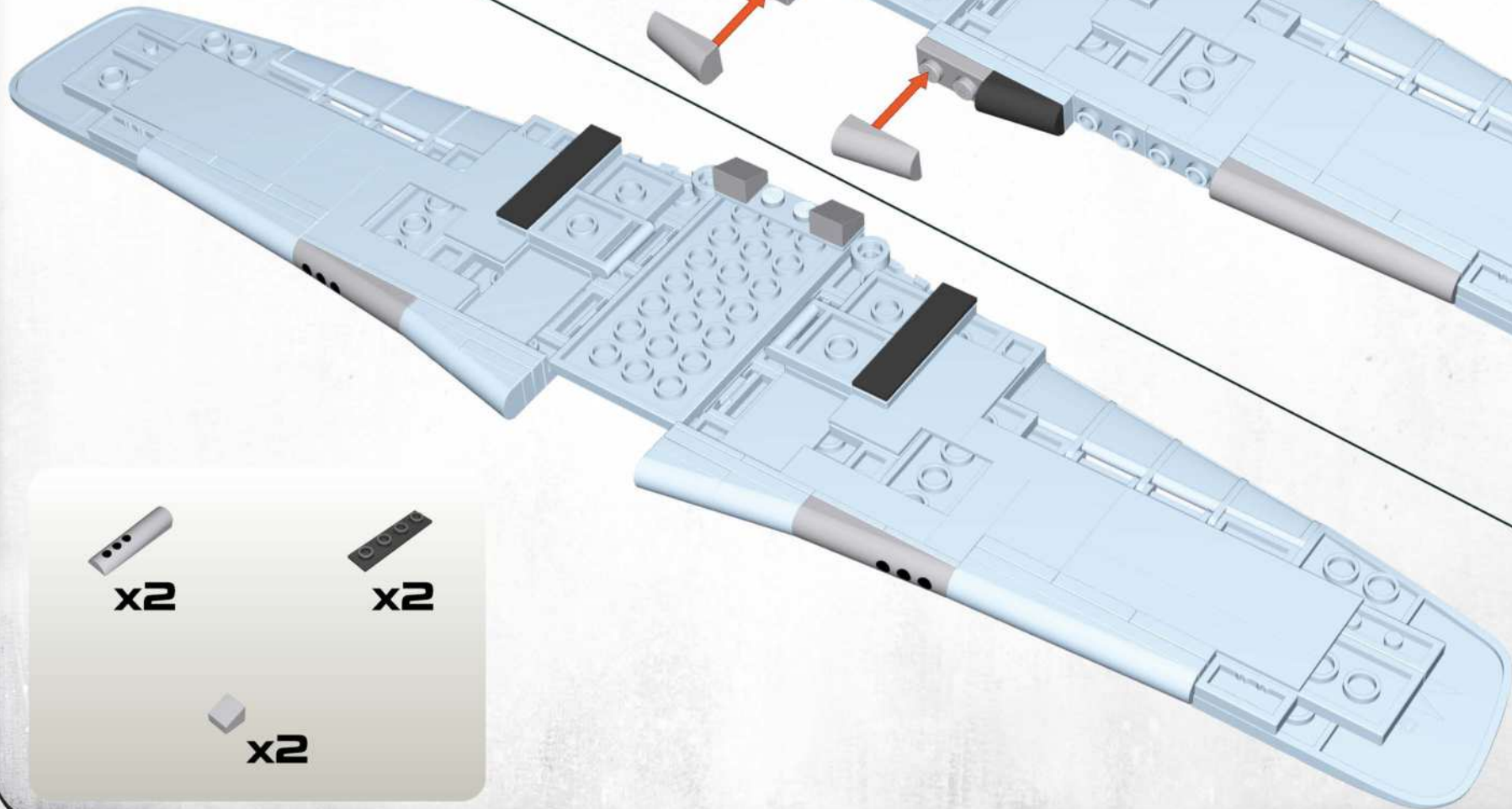

Grey Technic Pin x2 Black 1x2 Technic Brick x2
Grey Technic Pin x2



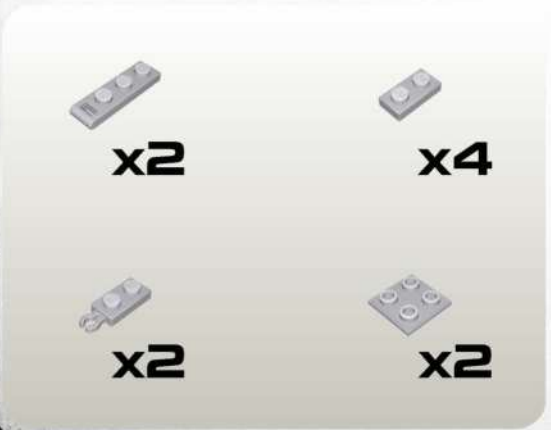
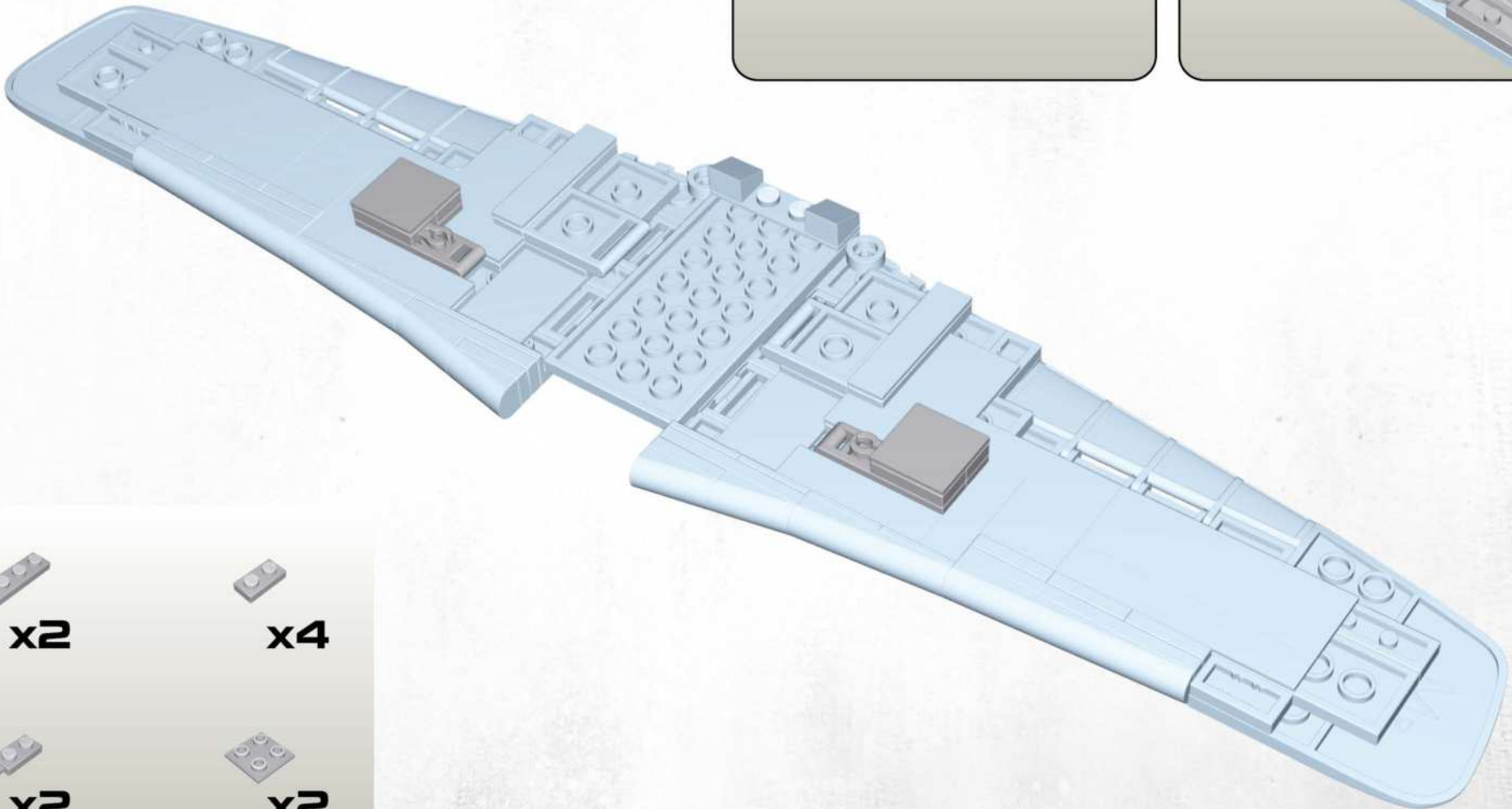
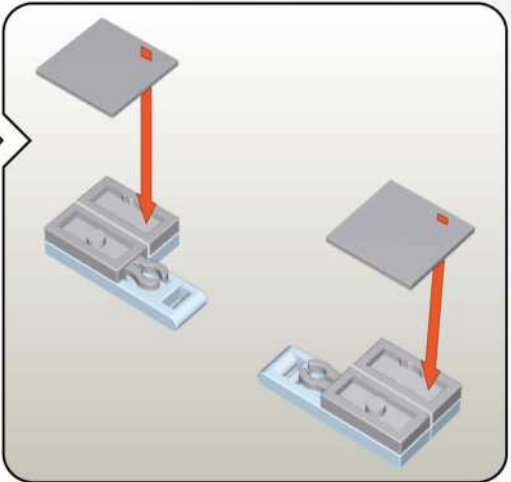
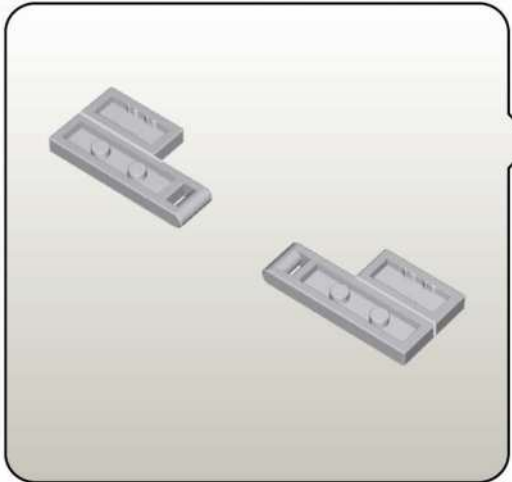

16

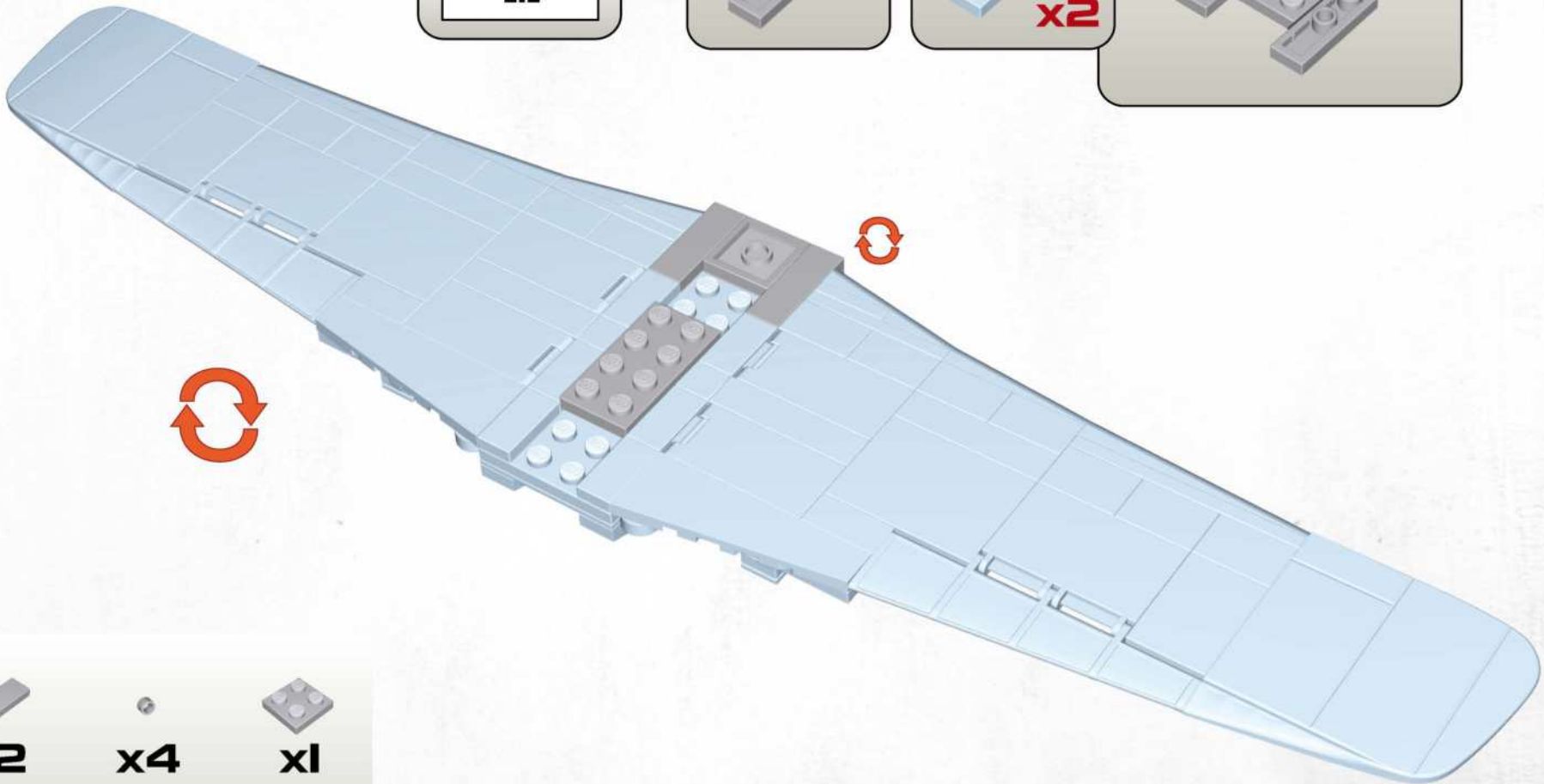
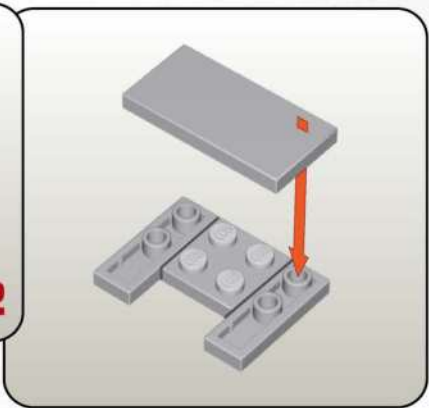
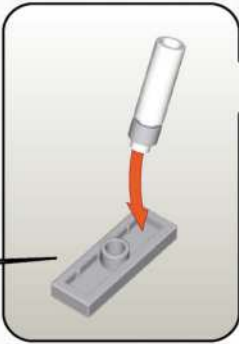

17

1:1



-  x2
-  x1
-  x4
-  x1
-  x1

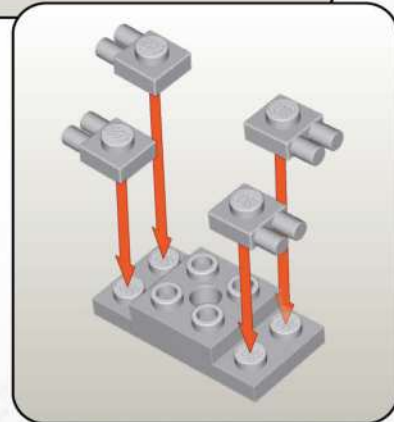
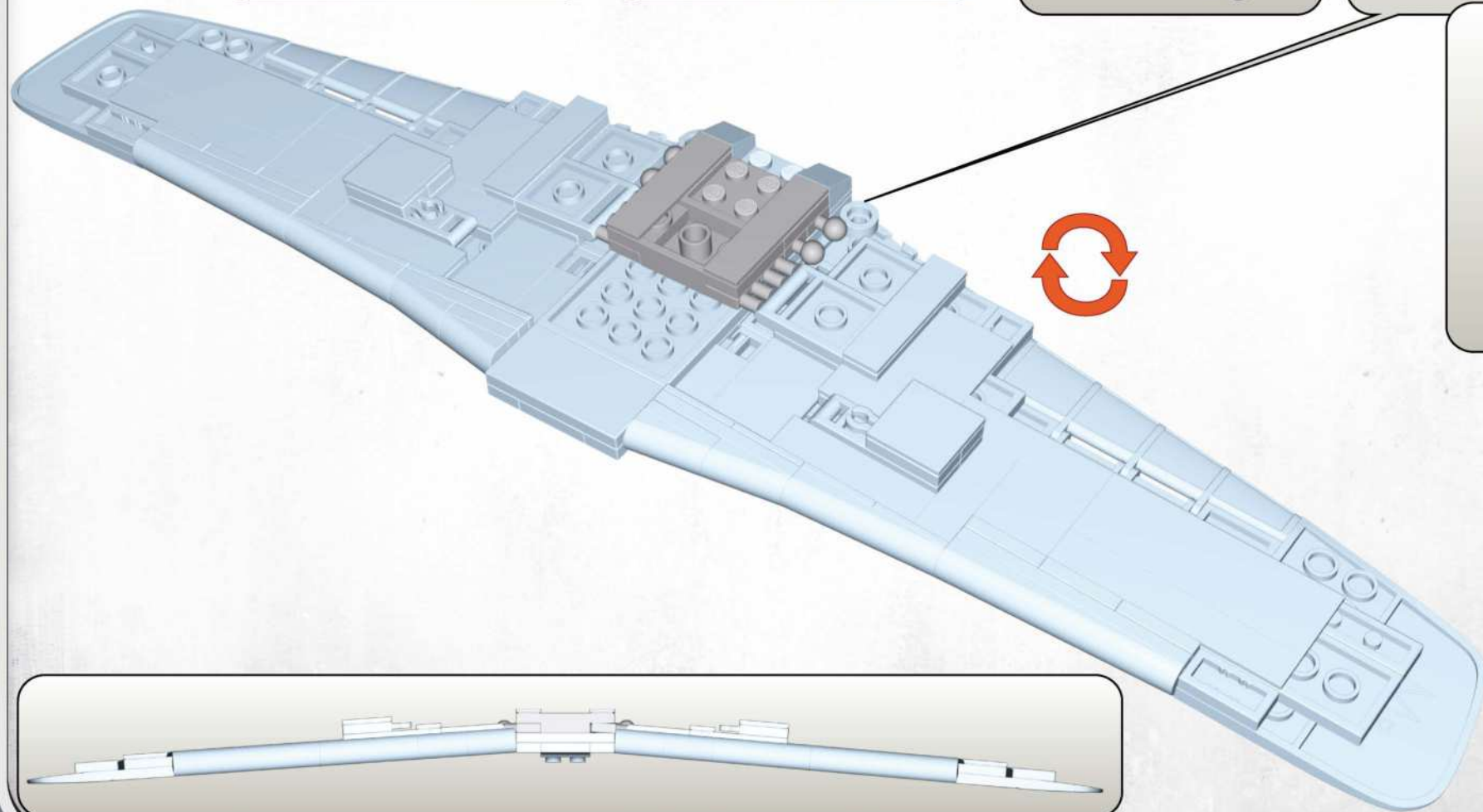
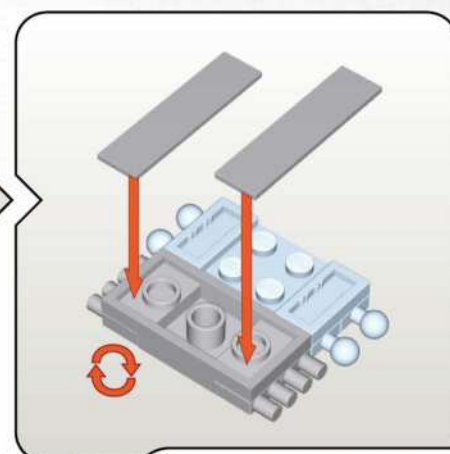
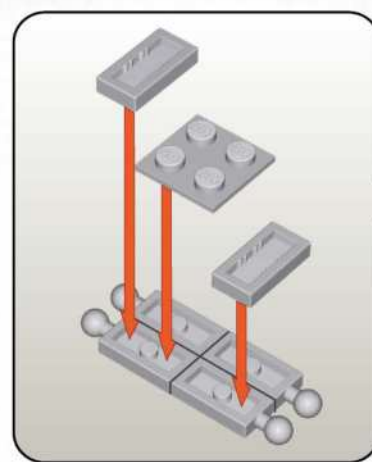
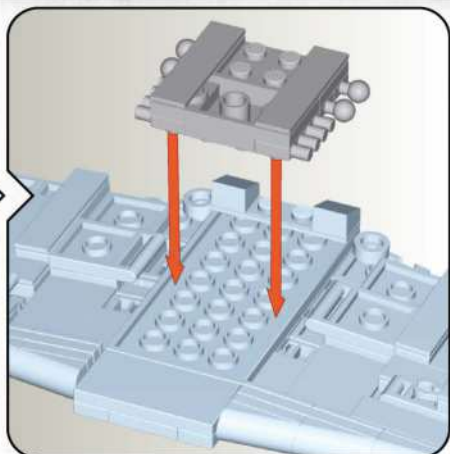

 x4

 x1

 x2

 x1

 x4

 x2

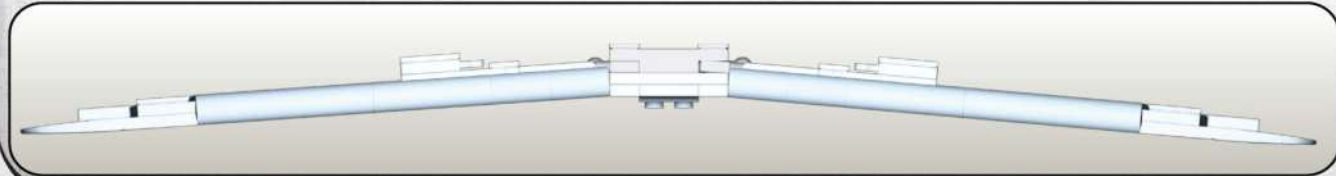

19

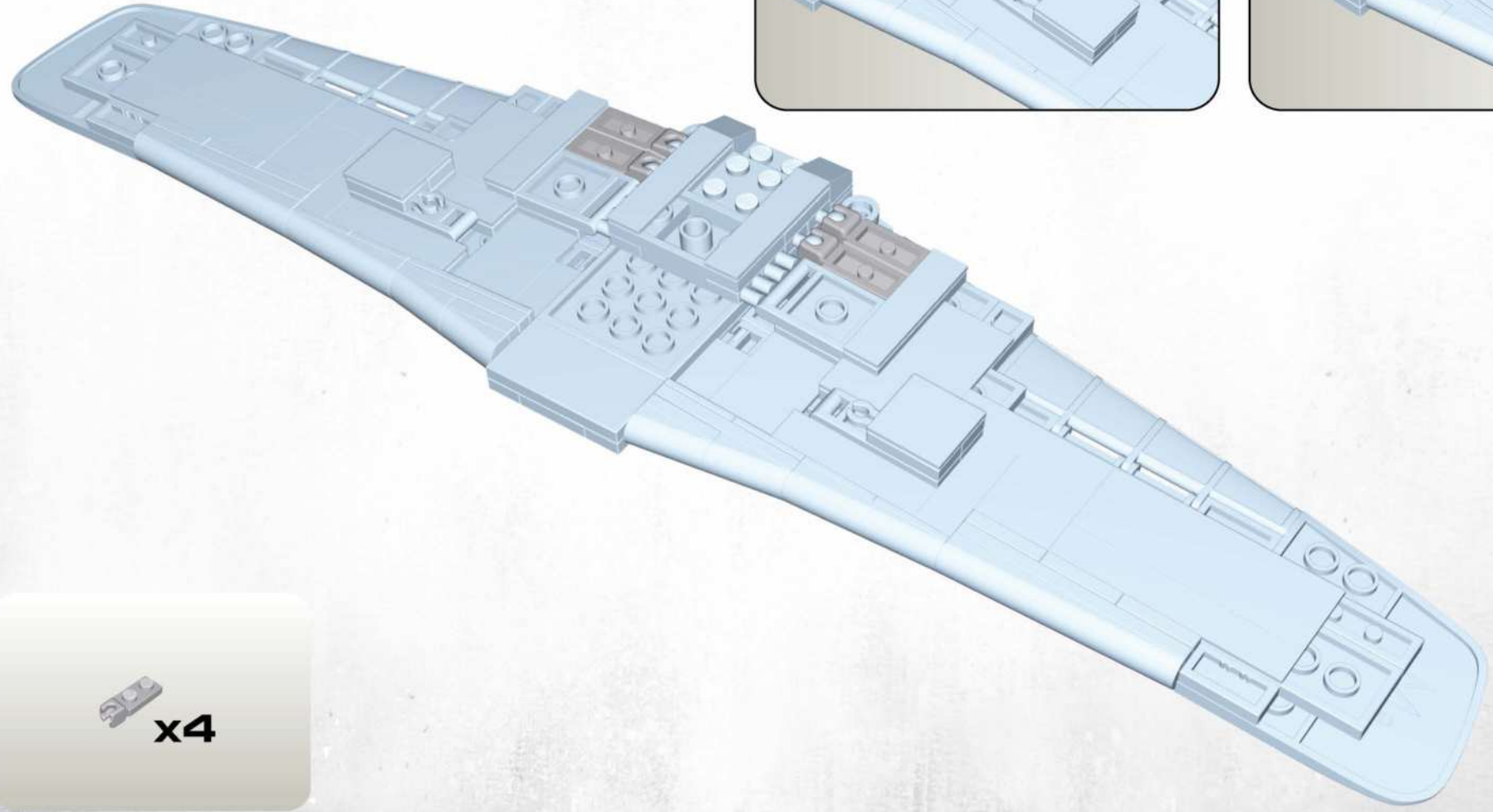
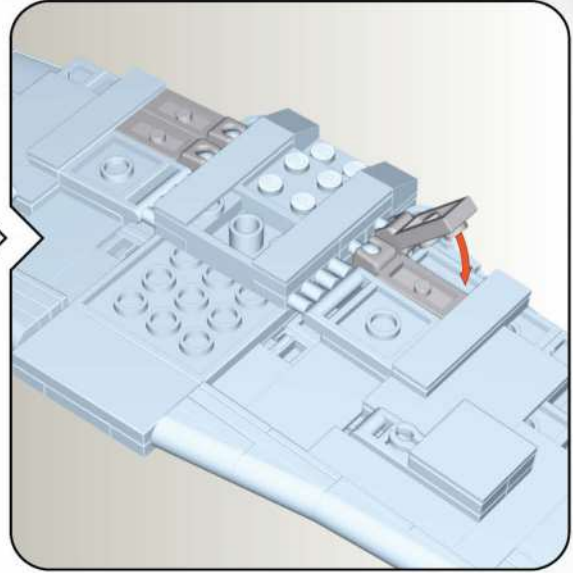
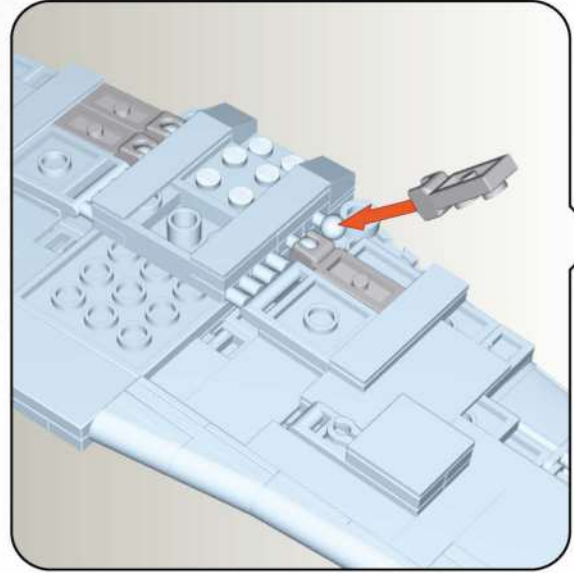

20

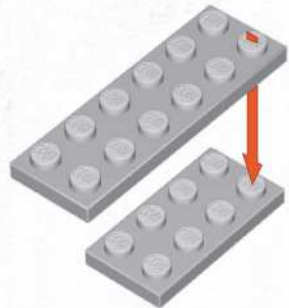

x1



x1

21

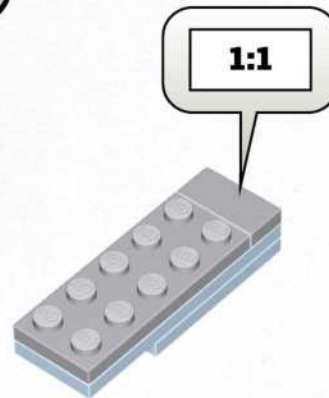

x1



x1

22

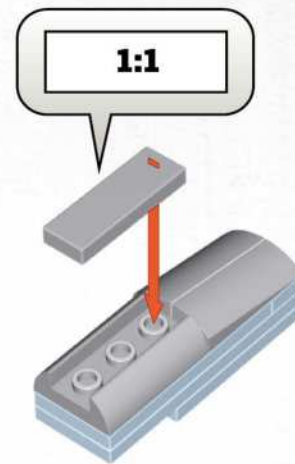

x1



x1



x1



x1

23

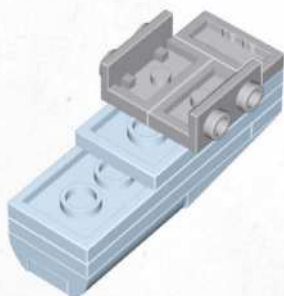

x2



x1

24

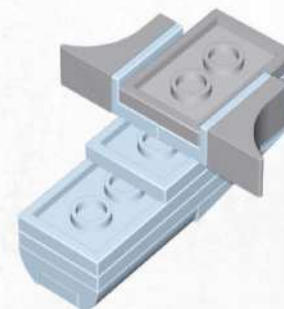

x1



x2

25

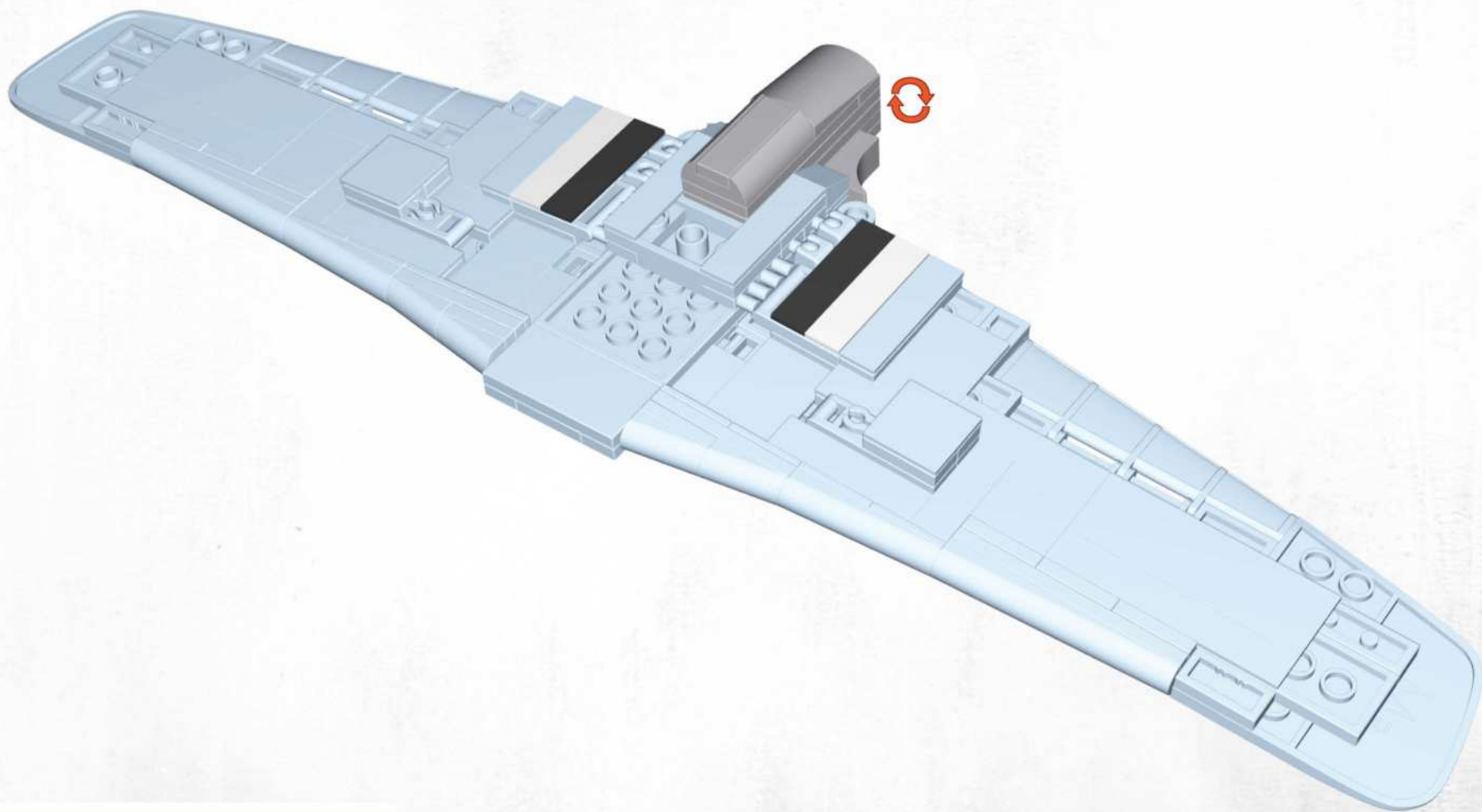







x2

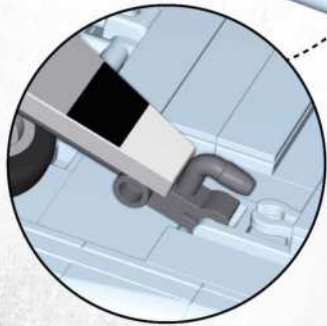
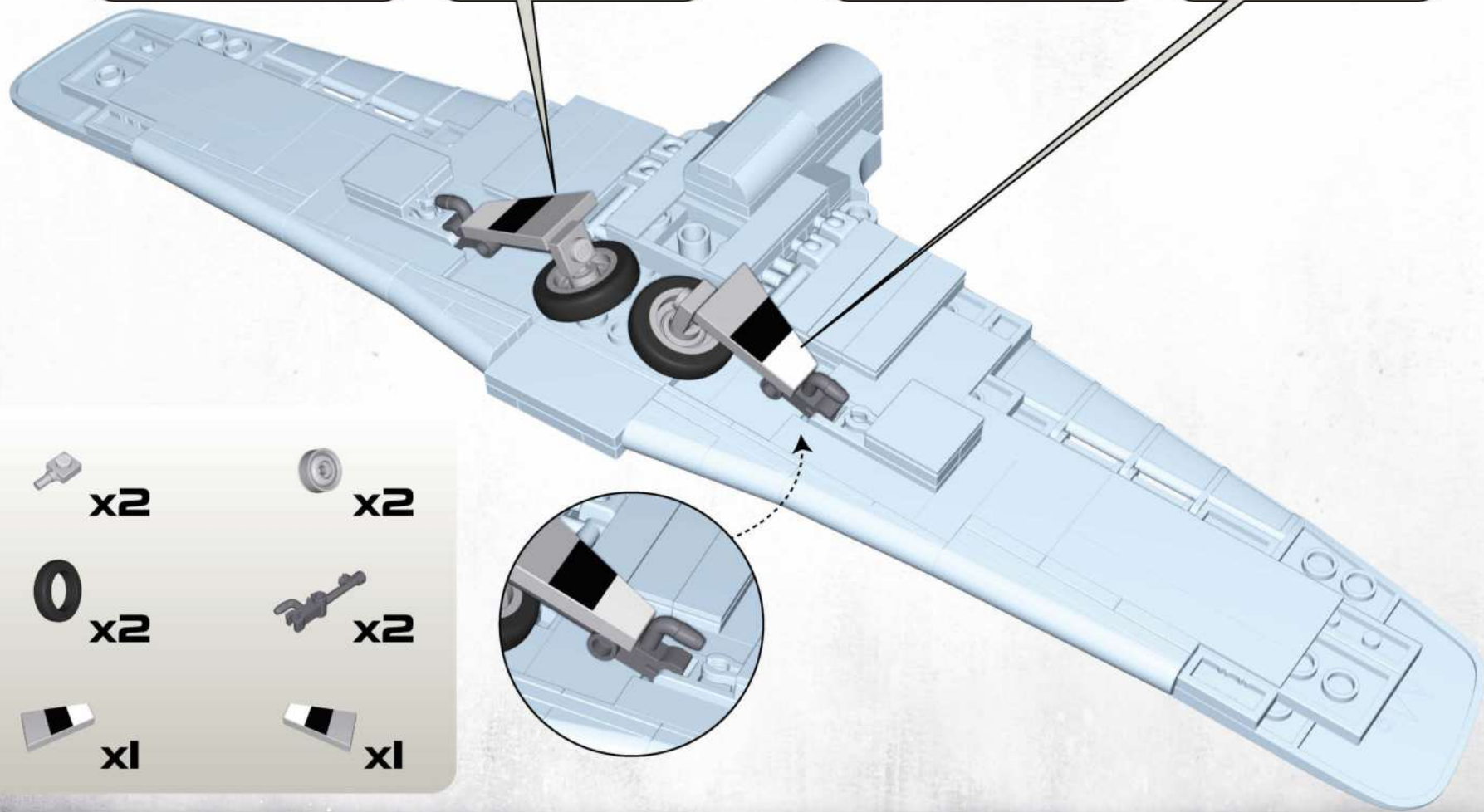
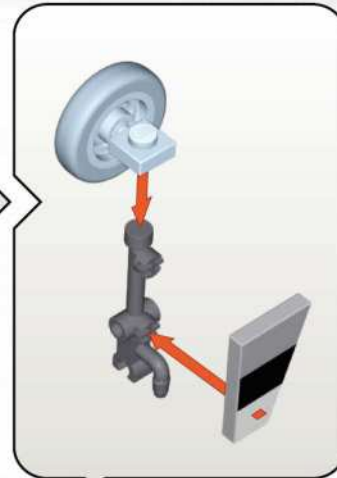
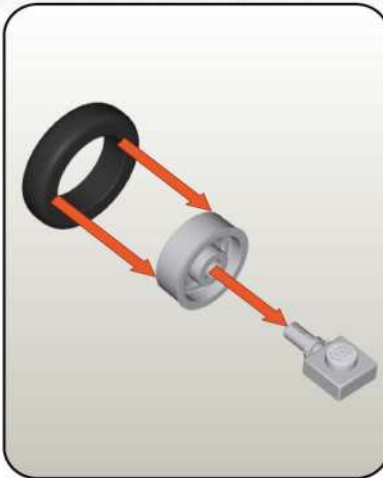
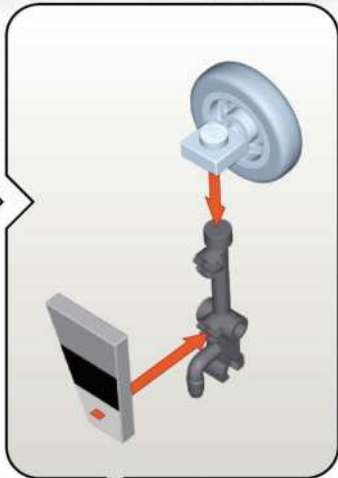
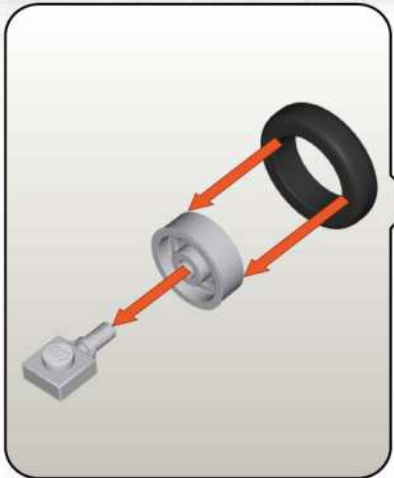

x2

26



-  x2
-  x2
-  x1
-  x2
-  x2
-  x1

30

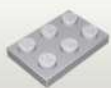
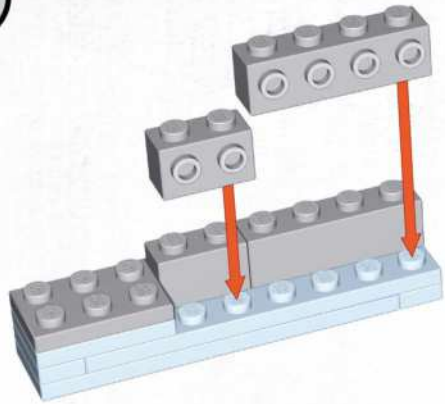

x1



x2



x2

31

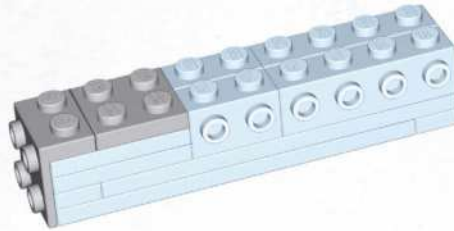

x1



x1

32

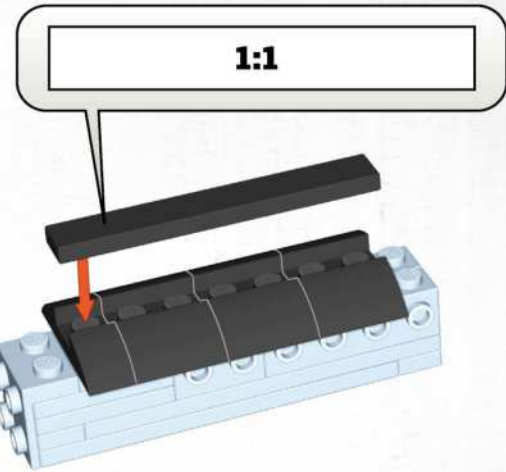

x3



x1



x1

33

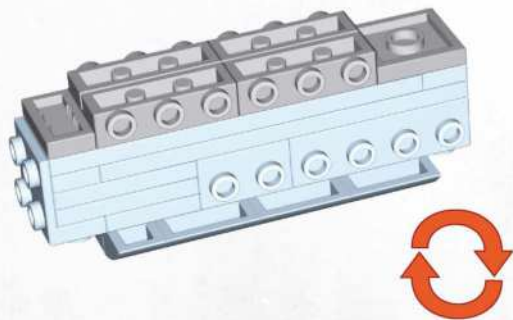

x1



x4



x1

34

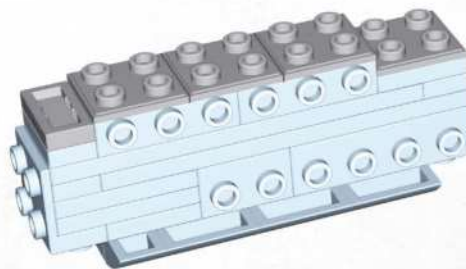

x1



x4

35

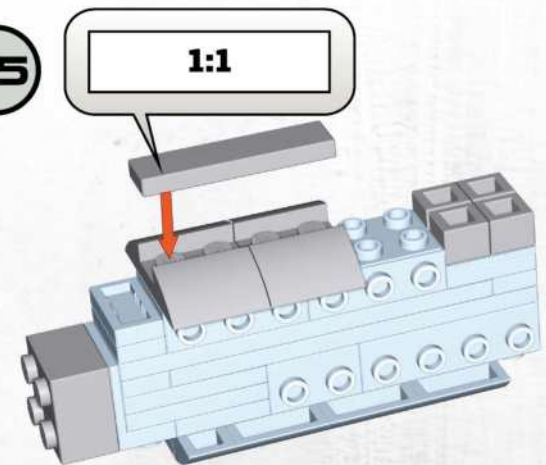

x1



x2



x1



x4

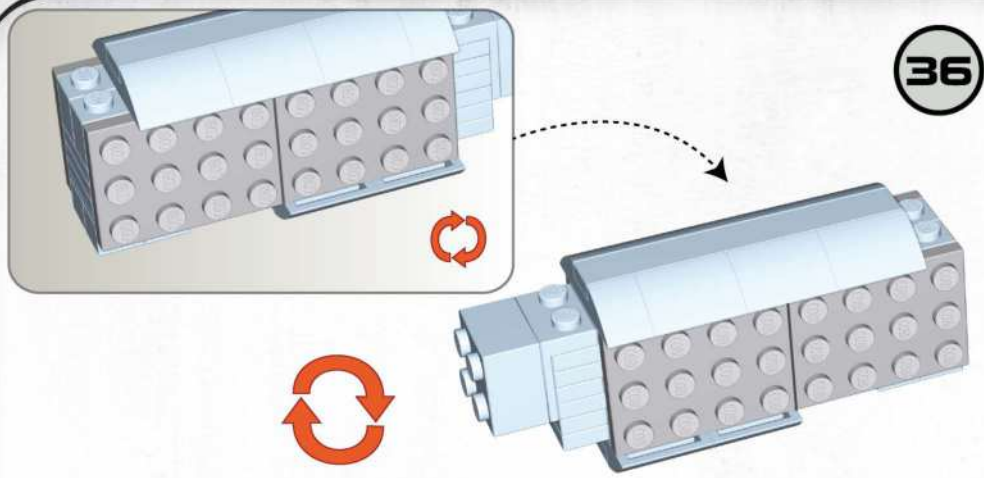

36

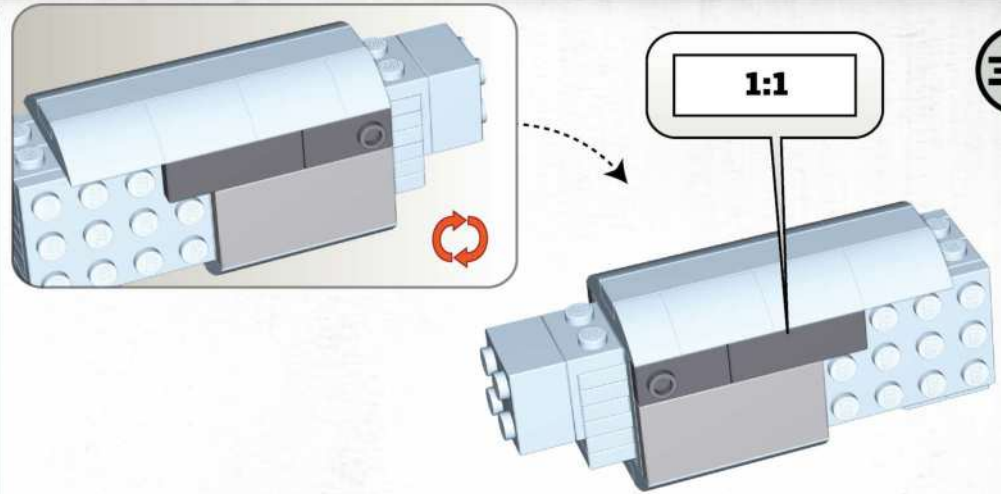

37

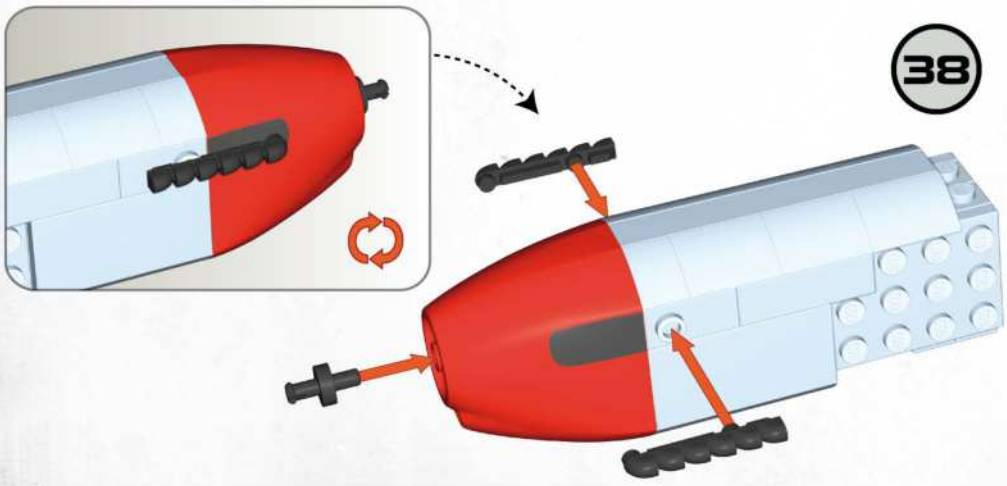

38

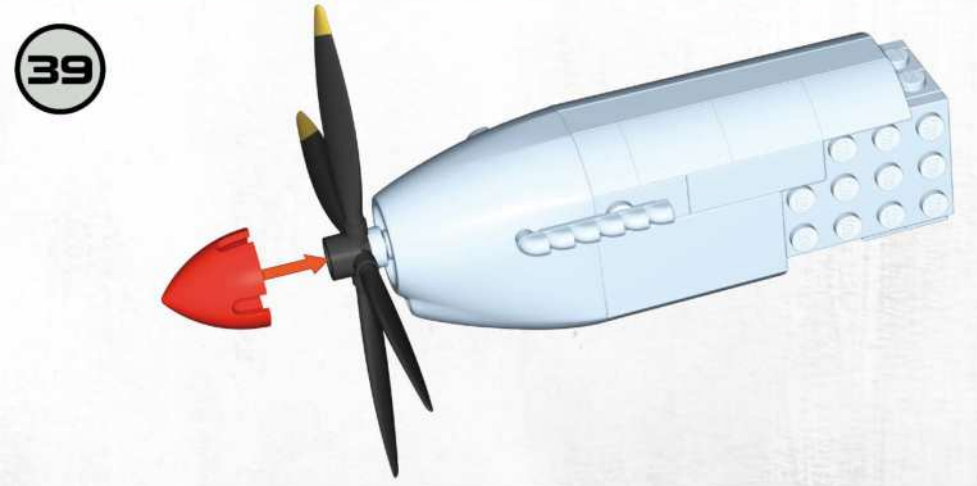

39



40

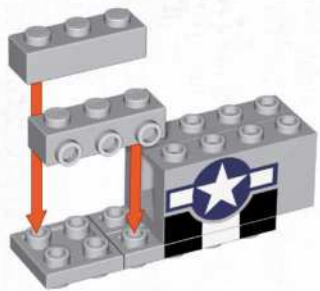

41

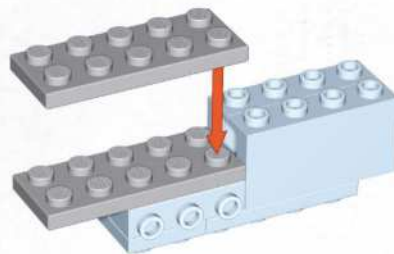

42

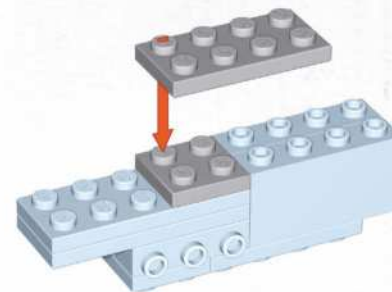

43



44

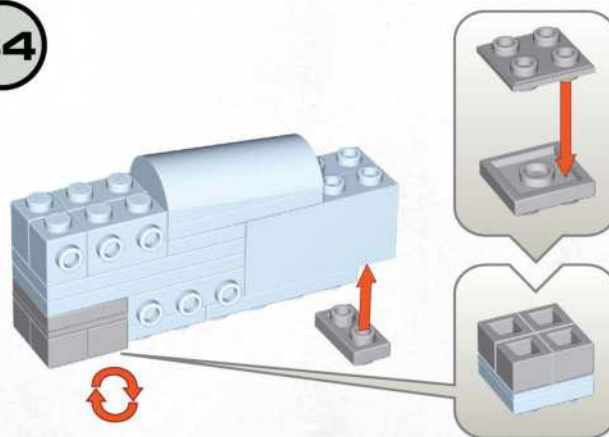

45

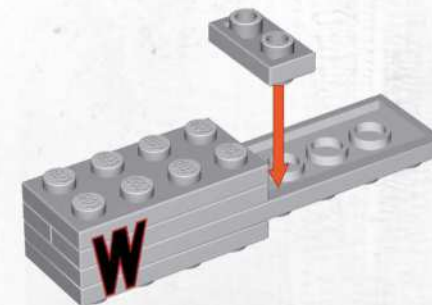

46

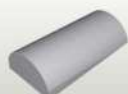
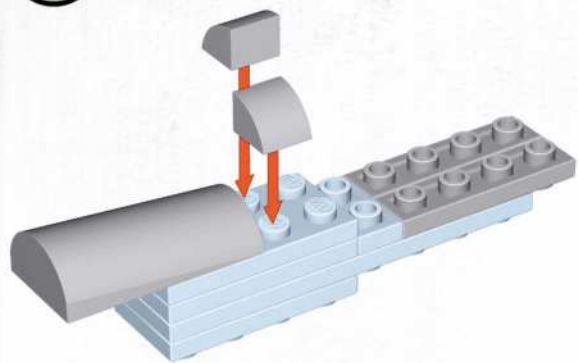

x1



x2



x2

47

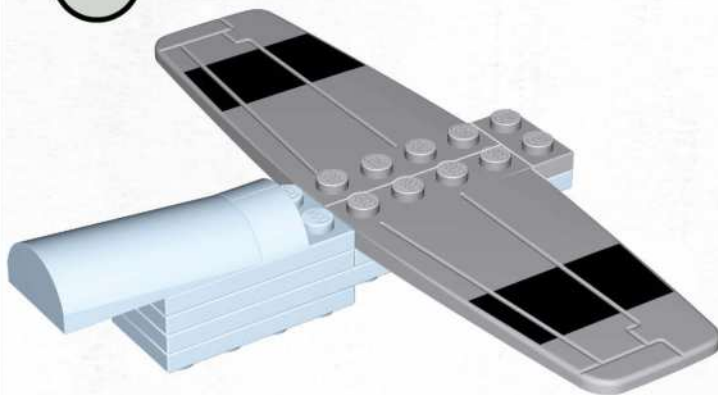

x1

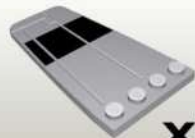

x1



x1

48

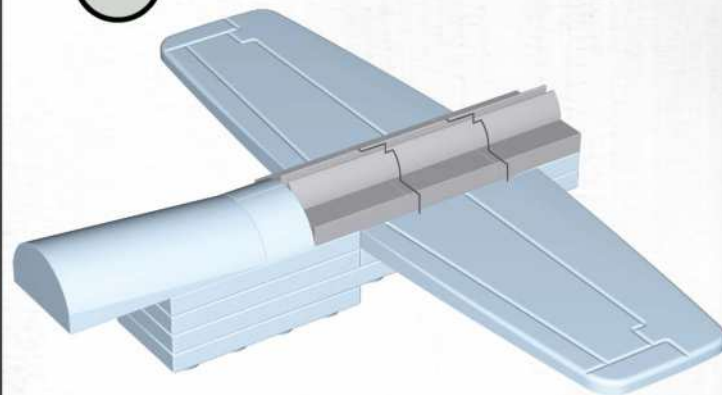

x3

49

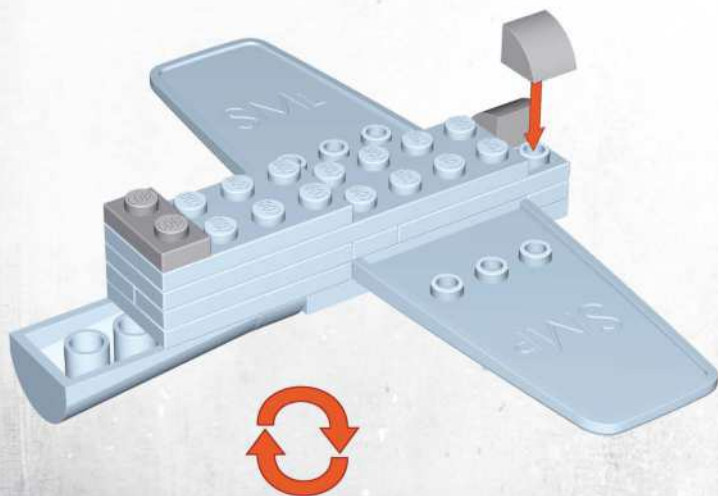

x1



x2

50

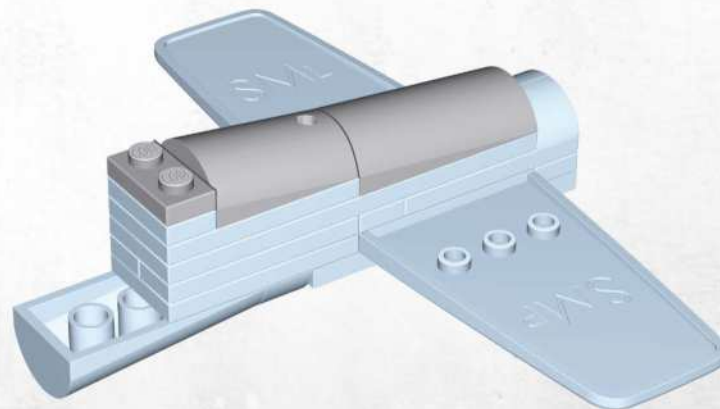

x1



x1

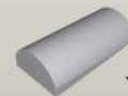

x1

51

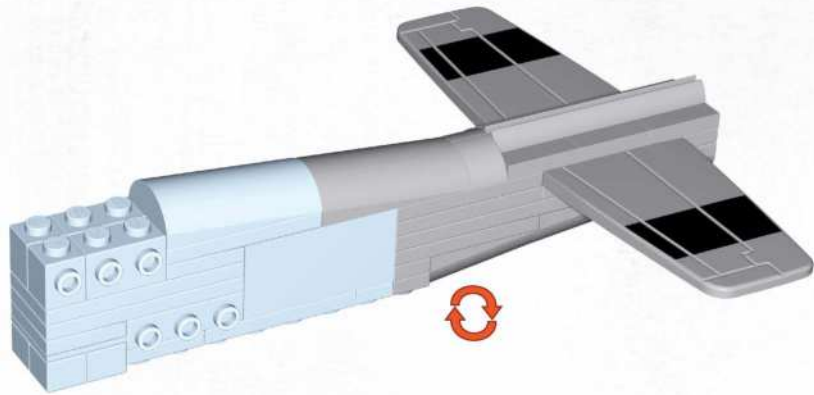

52

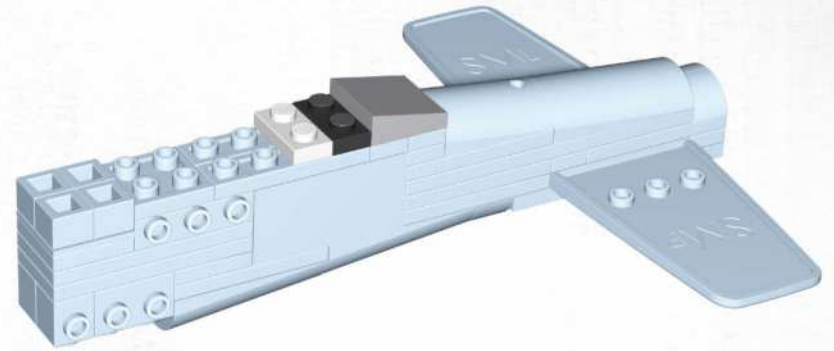

x1



x1



x1

53

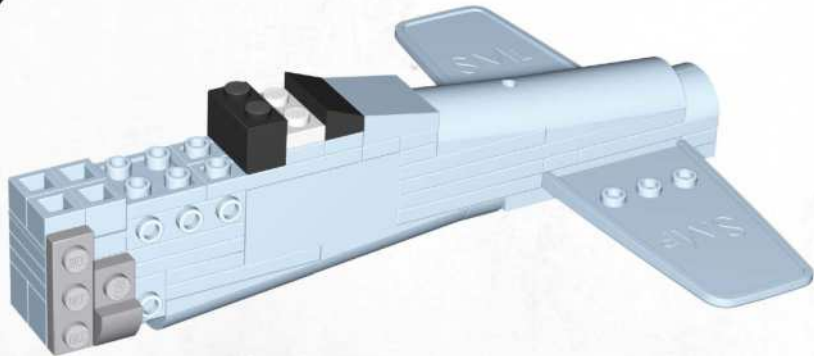

x1



x1



x1



x1



x1

54

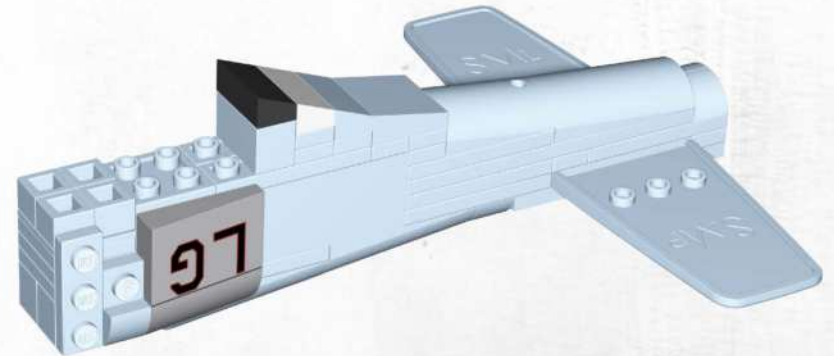

x1



x1



x1



x1

55

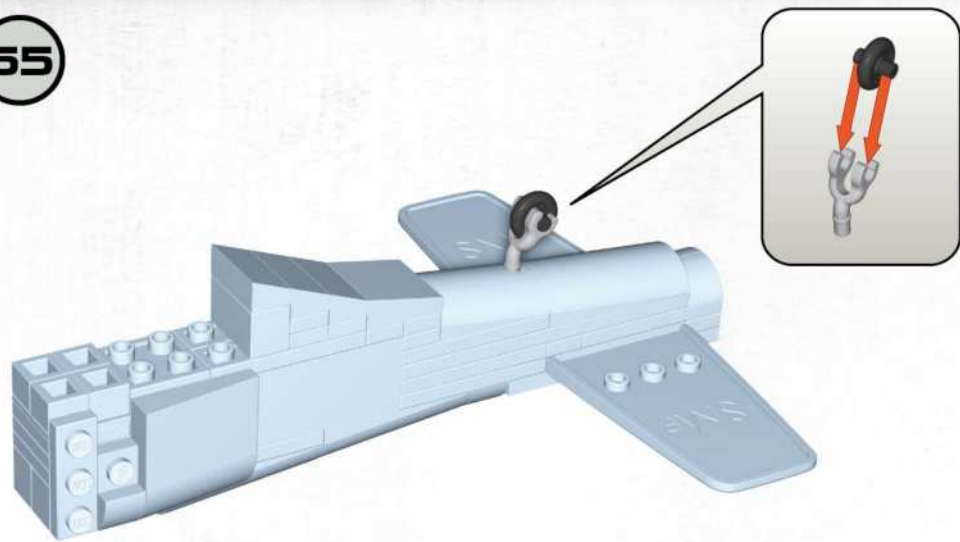

x1



x1

56



x1



x1



x1

57

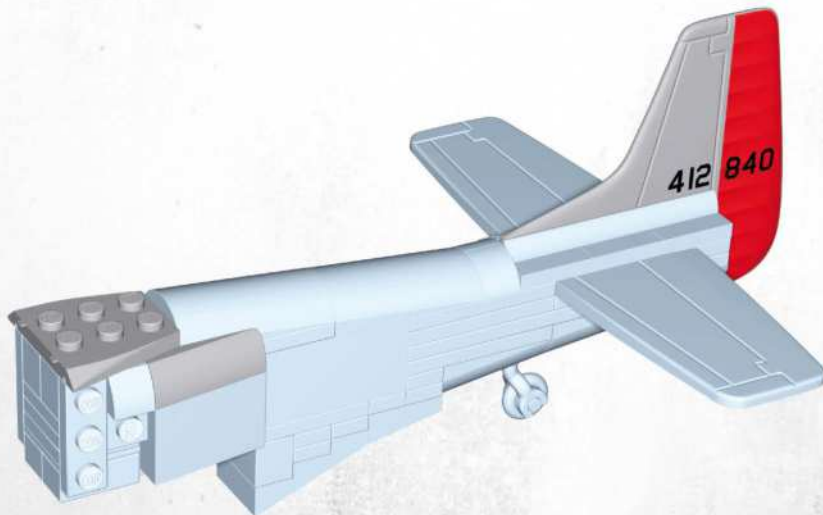

x1



x1



x1

58

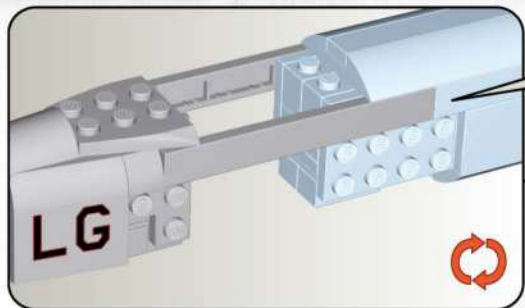

1:1

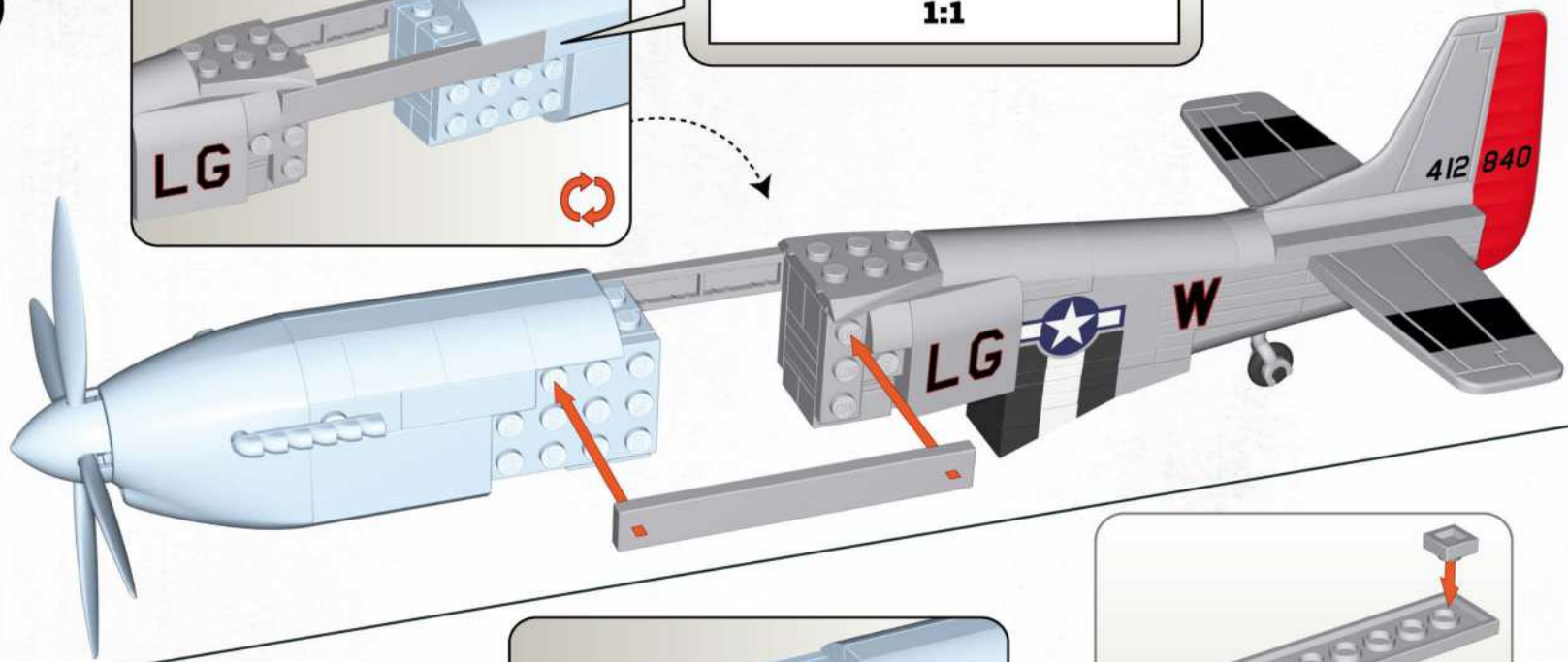

59

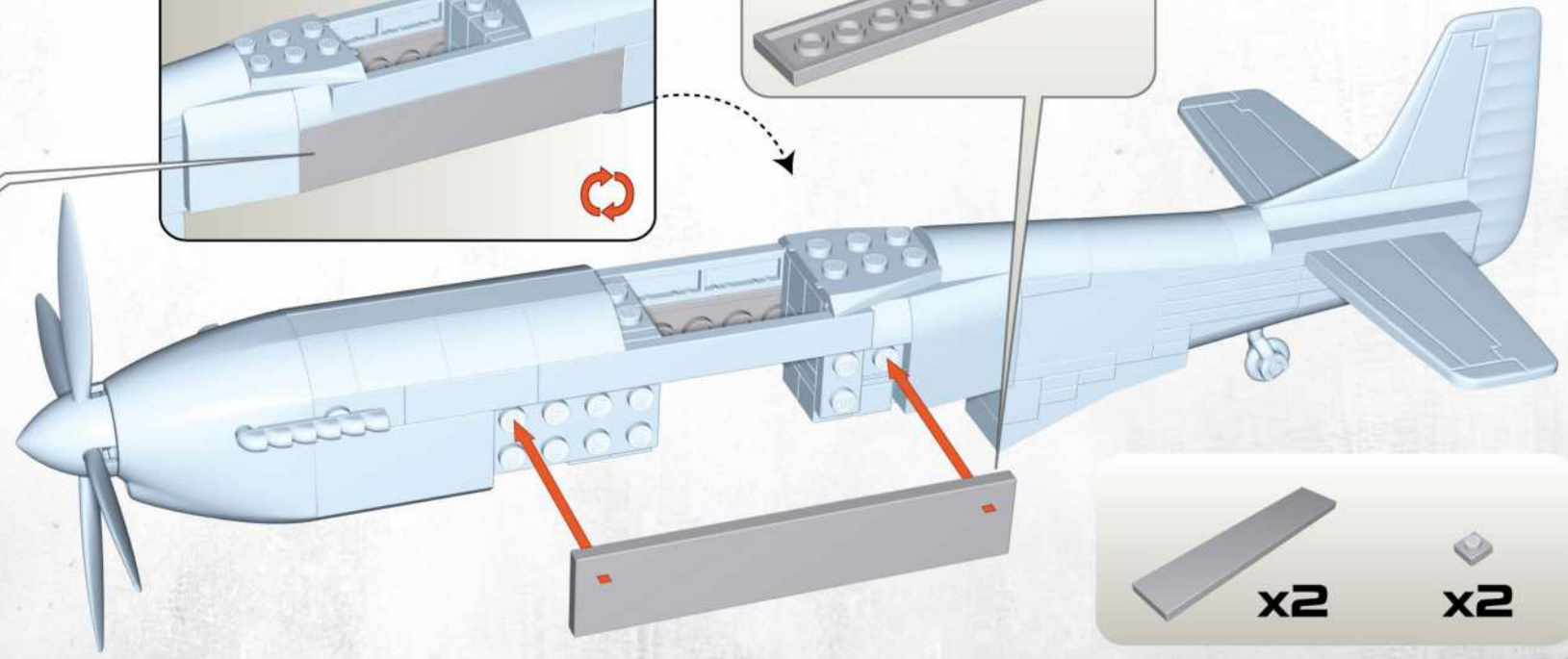
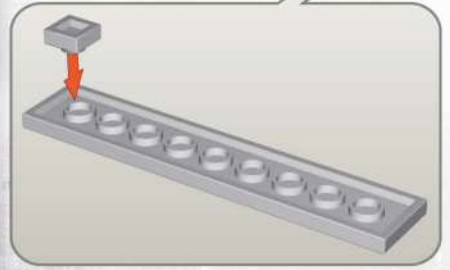
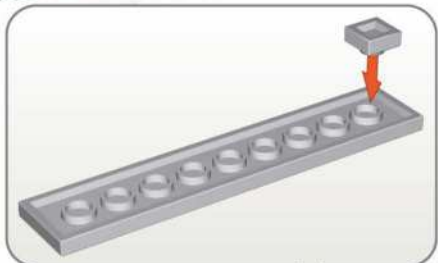
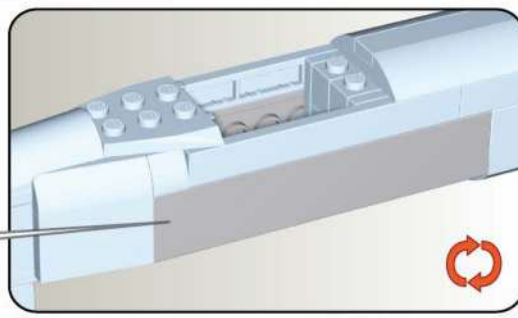

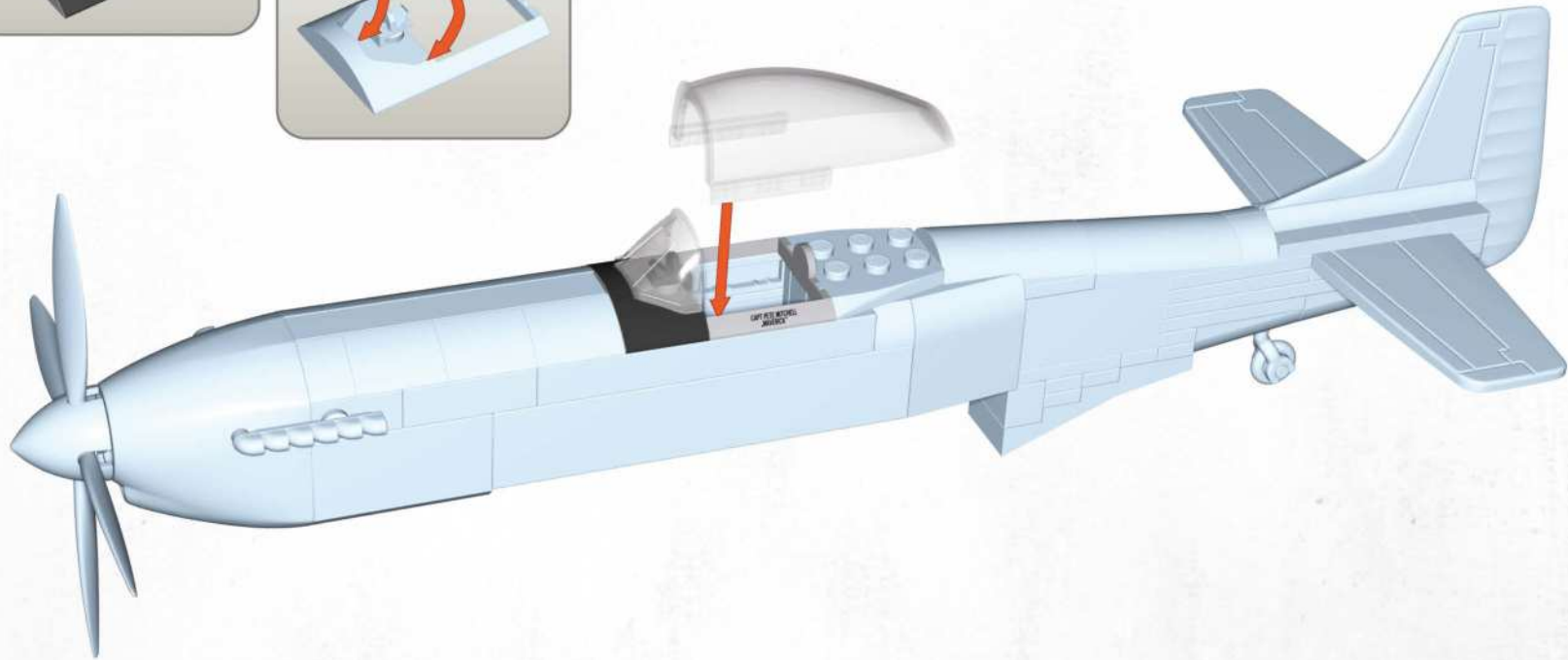

x1



x1



x1



x1

61

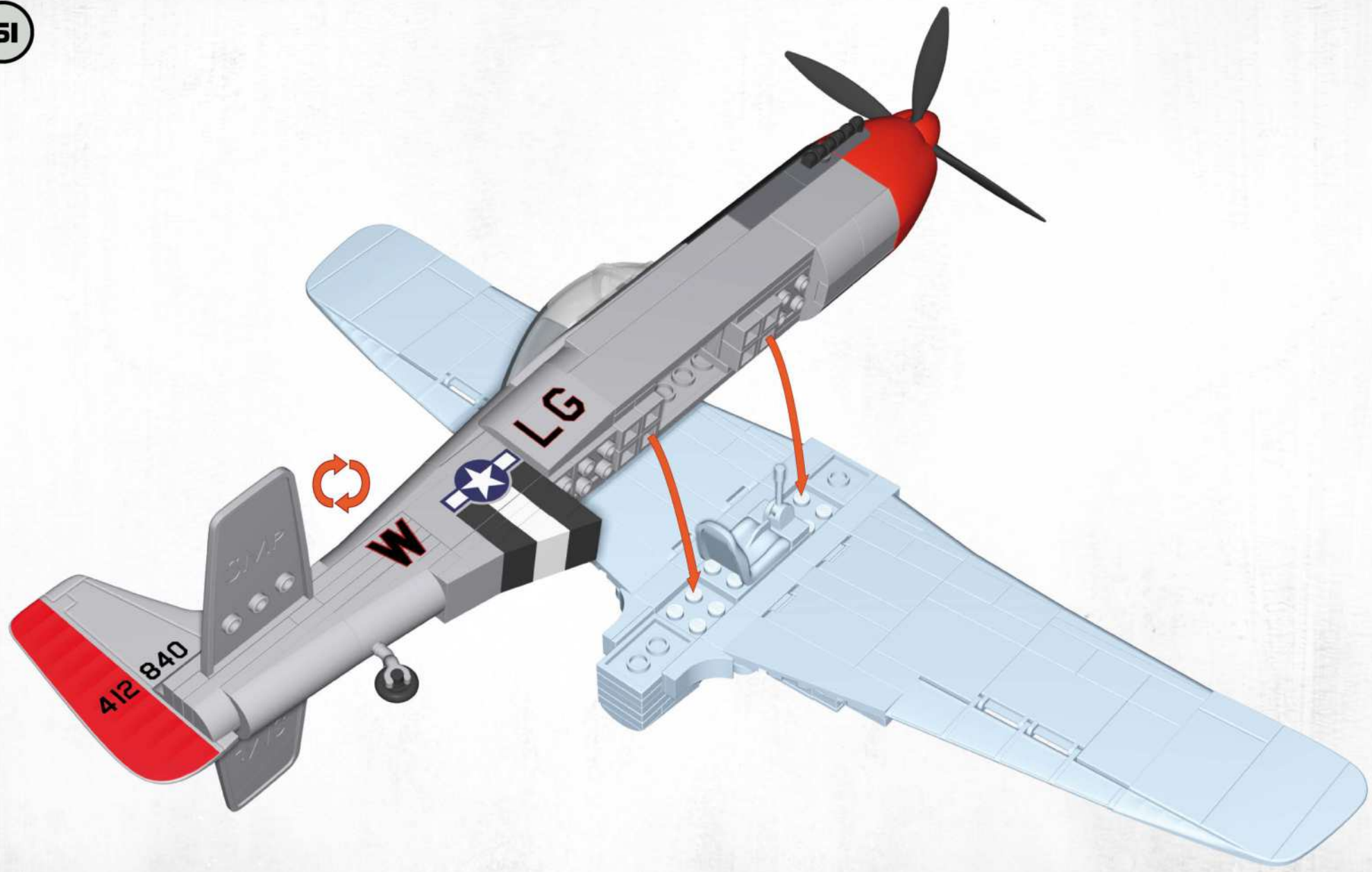

62



63

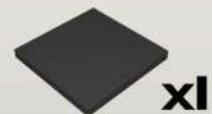
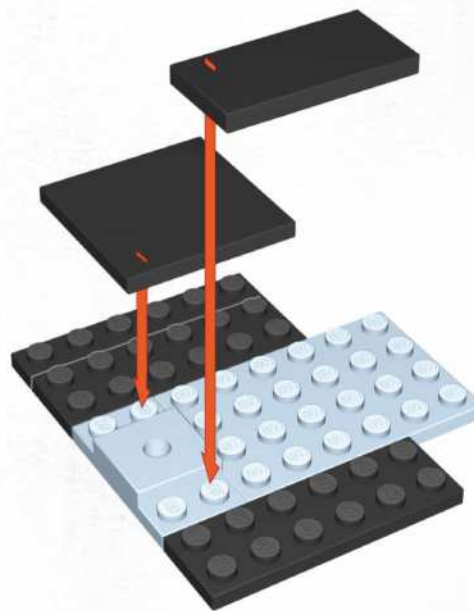

64

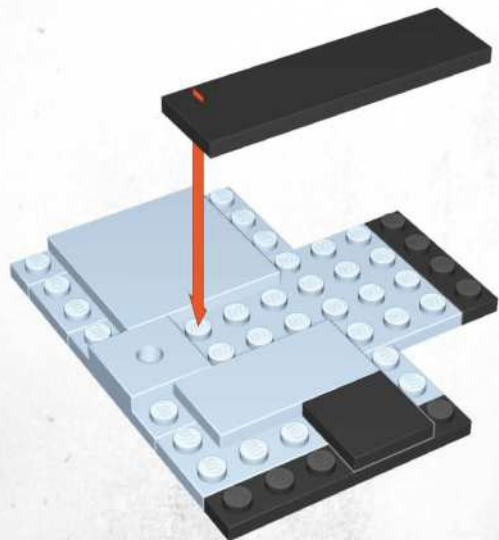

x1



x1



x1



x1

65

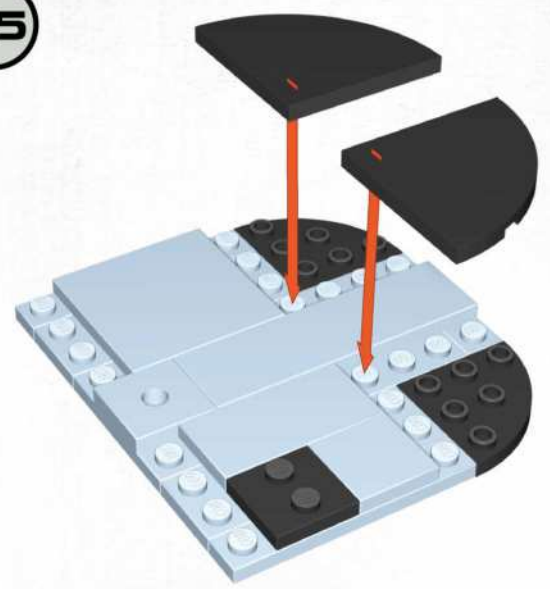

66

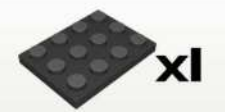
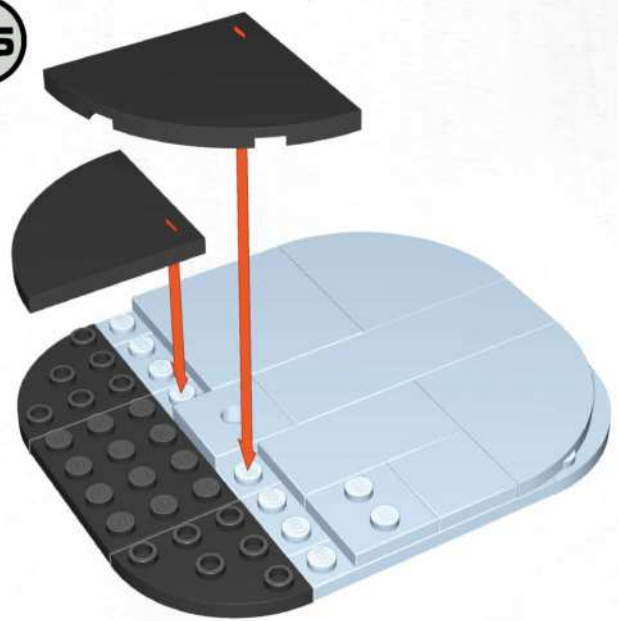

67

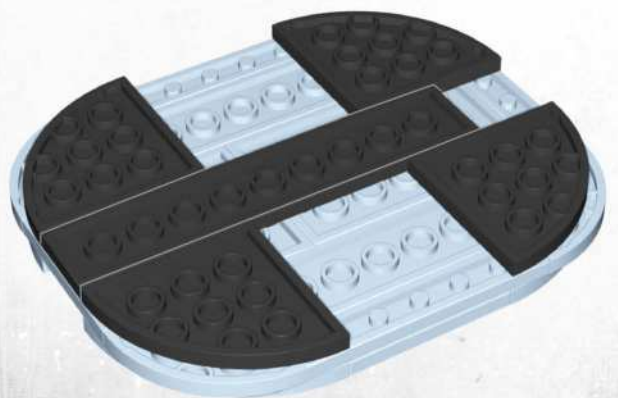

68



1:1



x2

x1

x1

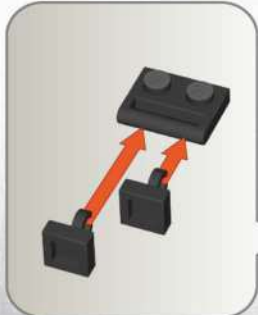
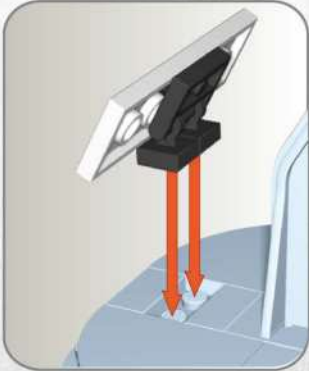



x1
71718



x1
140607



x1
154651



x1
154652



x1
140608



x2
107823



x1
126682

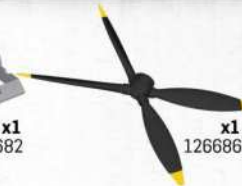

x1
126686



x1
154657



x1
154658



x1
154659



x1
92685



x2
120188



x1
102477



x1
92755



x2
146705



x1
126336



x1
92692



x1
92693

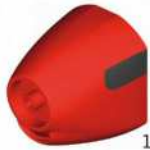

x1
126688



x2
92679



x1
106332



x1
58332



x1
43491



x2
43759



x1
126691



x1
126694



x1
126339



x2
92792



x2
83927



x1
43627



x2
92702



x1
43634



x1
92793



x1
83423



x1
154653



x1
43228



x2
59360



Produced under license from Boeing. Boeing and F/A-18 Hornet are trademarks of The Boeing Company.



F/A-18C HORNET™
5810



F-35®A LIGHTNING II®
5832



LOCKHEED MARTIN®, F-35®A Lightning II®, associated emblems and logos, and body designs of vehicles are either registered trademarks or trademarks of Lockheed Martin Corporation in the USA and/or other jurisdictions, used under license by COBI.



F-35®B LIGHTNING II®
5829



LOCKHEED MARTIN®, F-35®B Lightning II®, associated emblems and logos, and body designs of vehicles are either registered trademarks or trademarks of Lockheed Martin Corporation in the USA and/or other jurisdictions, used under license by COBI.

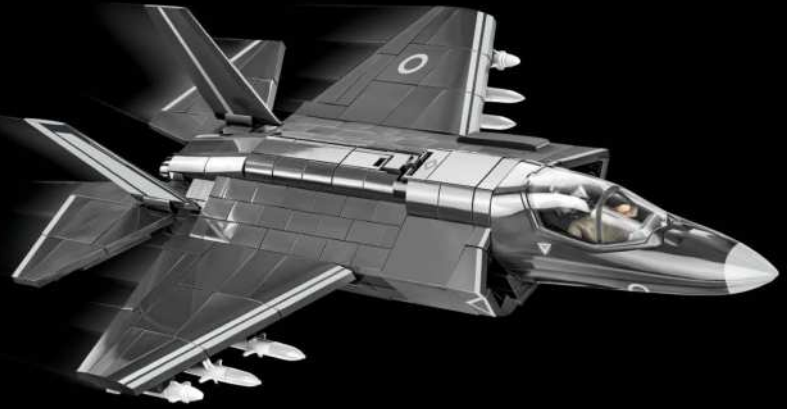

F-35®B LIGHTNING II®
5830

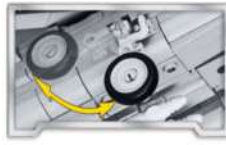

TOP GUN MAVERICK



F-14A TOMCAT™
5311A



F/A-18E SUPER HORNET™
5304



Produced under license from Boeing. Boeing, F/A-18 Super Hornet, the distinctive Boeing logos, product markings and trade dress are trademarks of The Boeing Company.



F/A-18E SUPER HORNET™
5305



TM & © 2023 Paramount Pictures. All Rights Reserved

NORTHROP GRUMMAN
F-14A Tomcat® is a registered trademark of Northrop Grumman Systems Corporation and is used under license by „Cobi“.



WWW.COBI BRICKS.COM

03-05846-338

For news and special deals

Find us on:
f cobr.bricks
cobr.klocki
COBI SA